

# Methodology for Determining the Greenhouse Gas Emissions Associated With the Production of Hydrogen

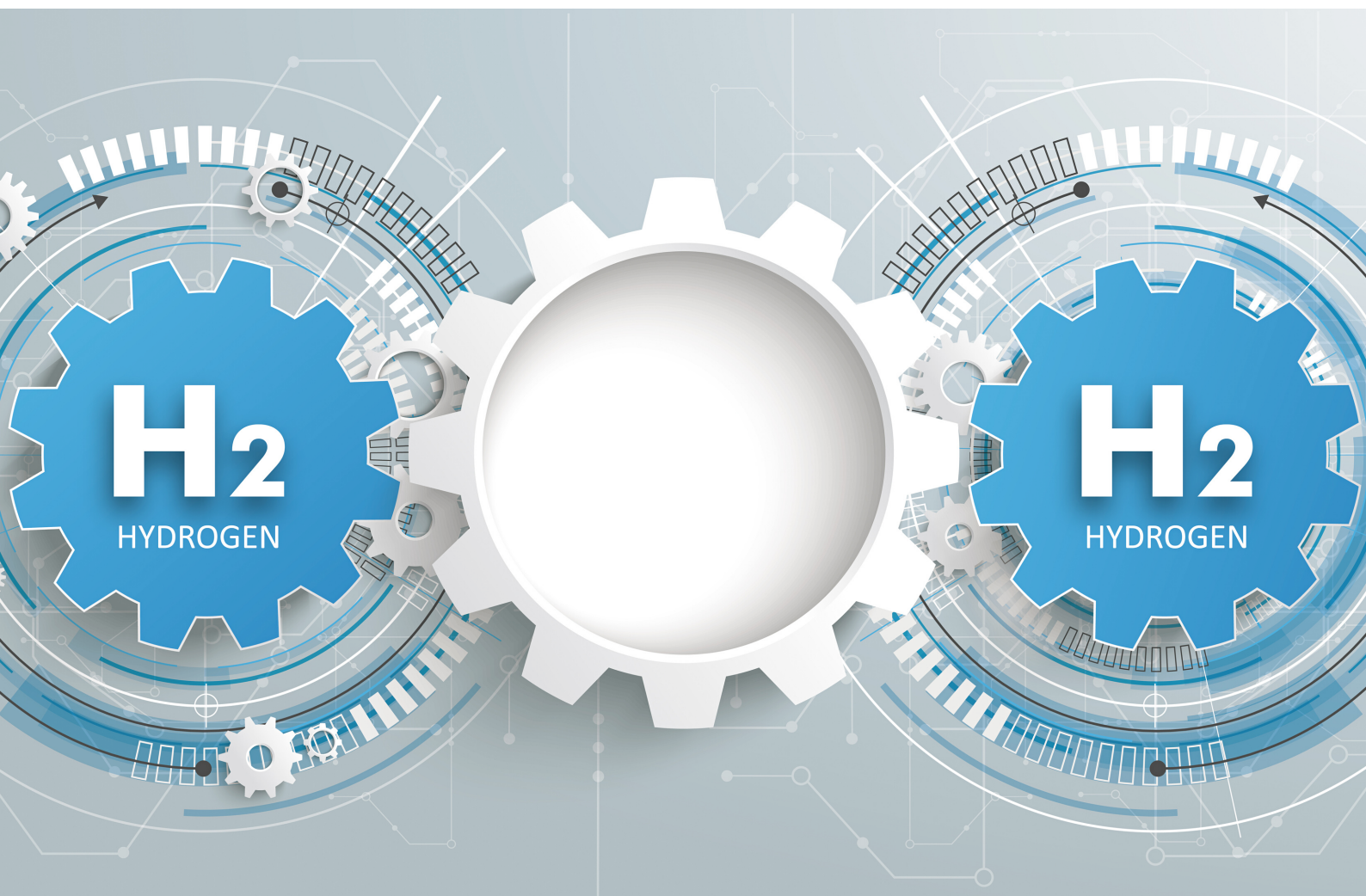

A Working Paper Prepared by the  
IPHE Hydrogen Production Analysis Task Force



VERSION 2 - NOVEMBER 2022

IPHE. All rights reserved.  
International Partnership for Hydrogen and Fuel Cells in the Economy  
Website: [www.iphe.net](http://www.iphe.net)  
Contact: [media@iphe.net](mailto:media@iphe.net)

Released November 2022  
Photo credits: © iStock

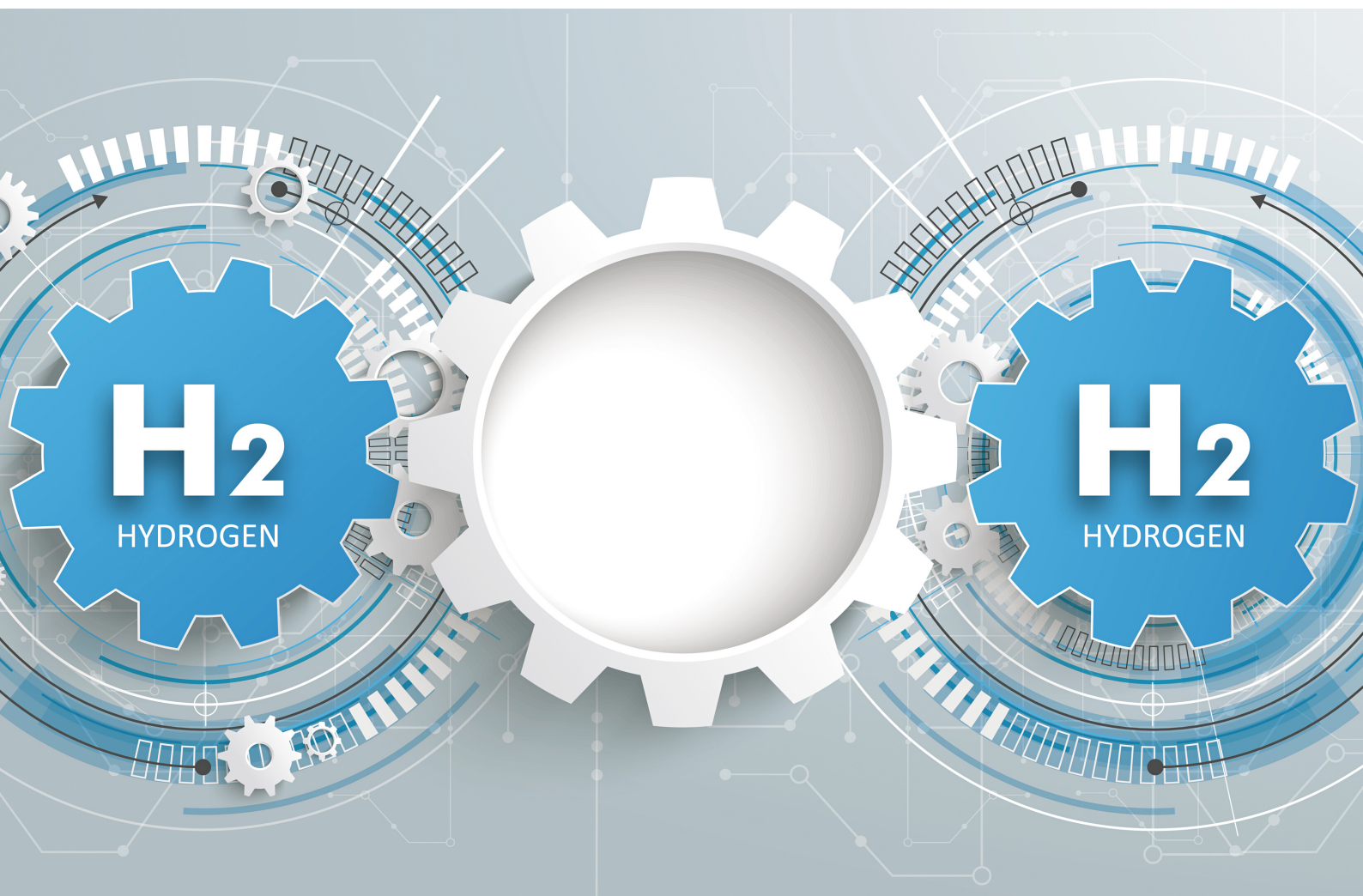

# Table of Contents

<b>Disclaimer</b>	<b>9</b>
<b>Acknowledgements</b>	<b>10</b>
<b>1 Foreword</b>	<b>11</b>
<b>2 Introduction</b>	<b>12</b>
<b>3 Scope</b>	<b>13</b>
<b>4 Normative References</b>	<b>14</b>
<b>5 Terms and Definitions</b>	<b>14</b>
<b>5.1 Quantification of the Carbon Footprint of a Product</b>	<b>14</b>
5.1.1 Allocation	14
5.1.2 Carbon Footprint of a Product, CFP	15
5.1.3 CFP Study	15
5.1.4 Product Category	15
5.1.5 Production Batch	15
5.1.6 Sub-Batch	15
5.1.7 Quantification of CFP	16
5.1.8 Greenhouse Gas, GHG	16
5.1.9 Carbon Dioxide Equivalent, CO <sub>2</sub> Equivalent, CO <sub>2</sub> e	16
5.1.10 Emissions	16
5.1.11 Emission Factor	17
5.1.12 Global Warming Potential, GWP	17
5.1.13 Greenhouse Gas Emission, GHG Emission	17
5.1.14 Greenhouse Gas Emission Factor, GHG Emission Factor	17
5.1.15 GHG Protocol	17
<b>5.2 Products, Product Systems and Processes</b>	<b>17</b>
5.2.1 Product	17
5.2.2 Product Flow	18
5.2.3 Product System	18
5.2.4 Co-Product	18
5.2.5 Energy from Renewable Sources or Renewable Energy	18
5.2.6 Geothermal Energy	19
5.2.7 Heating Value	19
5.2.8 Input	19
5.2.9 Intermediate Flow	19
5.2.10 Intermediate Product	19
5.2.11 Output	19
5.2.12 System Boundary	19
5.2.13 System Expansion	20
5.2.14 Process	20
5.2.15 Functional Unit	20
5.2.16 Reference Flow	20
5.2.17 Elementary Flow	21
5.2.18 Energy Flow	21
5.2.19 Functional Unit	21
<b>5.3 Life Cycle Assessment</b>	<b>21</b>
5.3.1 Cut-Off Criteria	21
5.3.2 Evaluation	21
5.3.3 Fugitive Emissions	22



5.3.4	Life Cycle .....	22
5.3.5	Life Cycle Assessment, LCA .....	22
5.3.6	Life Cycle Inventory Analysis, LCI .....	22
5.3.7	Location-Based Method.....	22
5.3.8	Market-Based Method.....	22
5.3.9	Inventory.....	23
5.3.10	Leakage (Secondary Effect).....	23
5.3.11	Materiality Threshold .....	23
5.3.12	Process Emissions .....	23
5.3.13	Releases .....	23
5.3.14	Scope.....	23
5.3.15	Scope 1 Inventory .....	23
5.3.16	Scope 2 Inventory .....	23
5.3.17	Scope 3 Inventory .....	24
5.3.18	Sensitivity Analysis.....	24
5.3.19	Sensitivity Check .....	24
5.3.20	Transparency .....	24
5.3.21	Uncertainty Analysis .....	24
5.3.22	Waste.....	24
<b>5.4</b>	<b>Organizations .....</b>	<b>25</b>
5.4.1	Interested Party .....	25
5.4.2	Intergovernmental Panel on Climate Change (IPCC) .....	25
5.4.3	Organization.....	25
<b>5.5</b>	<b>Data and Data Quality .....</b>	<b>25</b>
5.5.1	Data Quality .....	25
5.5.2	Double Counting .....	25
5.5.3	Primary Data .....	25
5.5.4	Secondary Data.....	26
5.5.5	Site-Specific Data .....	26
5.5.6	Uncertainty .....	26
<b>5.6</b>	<b>Abbreviated Terms .....</b>	<b>27</b>
<b>6</b>	<b>Evaluation Methods.....</b>	<b>27</b>
<b>6.1</b>	<b>Evaluation Basis.....</b>	<b>27</b>
<b>6.2</b>	<b>Evaluation Scope .....</b>	<b>28</b>
6.2.1	Product System Boundary.....	28
6.2.2	Selected Cut-Off Criteria .....	31
6.2.3	Evaluation Elements .....	32
6.2.4	Evaluation Cycle.....	32
<b>6.3</b>	<b>Life Cycle Impact Assessment .....</b>	<b>33</b>
6.3.1	Description of Data .....	33
6.3.2	Emissions Accounting .....	34
6.3.3	Emissions Inventory .....	34
<b>6.4</b>	<b>Life Cycle Assessment Report .....</b>	<b>48</b>
<b>7</b>	<b>Evaluation Process .....</b>	<b>48</b>
<b>7.1</b>	<b>Application .....</b>	<b>48</b>
<b>7.2</b>	<b>Document Verification.....</b>	<b>48</b>
<b>7.3</b>	<b>On-Site Verification .....</b>	<b>48</b>
7.3.1	Document Verification and Submission Materials.....	48



7.4	On-Site Verification Steps .....	49
<b>8</b>	<b>Evaluation Conclusion .....</b>	<b>49</b>
<b>Appendix P1</b>	<b>Hydrogen Production Pathway - Electrolysis .....</b>	<b>50</b>
P1.1.	Electrolysis Process Description .....	50
P1.2.	Electrolysis Overview.....	51
P1.3.	Emissions Sources in Electrolysis.....	51
P1.4.	Allocation for the electrolysis pathway .....	52
P1.5.	Information to be reported.....	52
<b>Appendix P2</b>	<b>Hydrogen Production Pathway – Steam Methane Reforming (with Carbon Capture and Storage - CCS) .....</b>	<b>54</b>
P2.1.	SMR/CCS Process Description .....	54
P2.2.	SMR/CCS Overview .....	55
P2.3.	Emissions Sources In SMR/CCS .....	56
P2.4.	Allocation for the SMR/CCS Pathway .....	57
P2.5.	Information to Be Reported for H2 production by SMR/CCS .....	57
<b>Appendix P3</b>	<b>Hydrogen Production Pathway – Industrial By-Product.....</b>	<b>60</b>
P3.1.	By-Product Process Description .....	60
P3.2.	By-Product Overview.....	62
P3.3.	Emissions Sources in By-Product.....	63
P3.4.	Allocation for The By-Product Pathway .....	64
<b>Appendix P4</b>	<b>Hydrogen Production Pathway – Coal Gasification (With Carbon Capture and Storage - CCS) .....</b>	<b>69</b>
P4.1.	Coal Gasification/CCS Process Description .....	69
P4.2.	Coal Gasification /CCS Overview .....	73
P4.3.	Emissions Sources In Coal Gasification /CCS.....	74
P4.4.	Allocation for The Coal Gasification /CCS Pathway.....	75
P4.5.	Information To Be Reported .....	79
<b>Appendix P5: Hydrogen production pathway – Biomass as feedstock (with Carbon Capture and Storage - CCS) .....</b>		<b>82</b>
P5.1.	Biomass definition.....	82
P5.2.	Biomass waste definition.....	82
a.	Determination of waste.....	83
b.	Calculation of waste emissions avoidance: equations and examples .....	83
P5.3.	Biomass-Based Hydrogen Routes: General Process Description .....	85
P5.4.	Biodigestion / CCS Process Description .....	87
P5.5.	Gasification /CCS Process Description .....	89



P5.6.	Emissions sources in Biomass-Based Hydrogen Routes/CCS .....	91
P5.7.	Allocation for the Biomass/CCS pathway .....	92
P5.8.	Information to be reported.....	93
P5.9.	References .....	95
<b>Appendix P6: Hydrogen Production Pathway – Auto thermal Reforming with Carbon Capture and Storage..... 98</b>		
P6.1.	ATR/CCS Process Description .....	98
P6.2.	ATR/CCS Overview .....	99
P6.3.	Emissions Sources in ATR/CCS .....	100
P6.4.	Allocation for the ATR/CCS pathway.....	101
P6.5.	Information to be reported for H2 production by ATR .....	101
<b>Appendix C1: Ammonia as a Hydrogen Carrier ..... 104</b>		
C1.1.	Ammonia Process Description .....	104
C1.2.	System boundary.....	104
C1.3.	Ammonia Production from Natural Gas or Biogas with Carbon Capture and Sequestration .....	105
C1.4.	Ammonia Production from Gasification of Fossil Fuels, Waste, or Solid Biomass with Carbon Capture and Sequestration .....	110
C1.5.	Ammonia Production from Hydrogen and Nitrogen .....	113
C1.6.	Ammonia Cracking for Hydrogen Production .....	115
<b>Appendix C2: Liquid Hydrogen as carrier ..... 119</b>		
C2.1.	Liquefaction .....	119
C2.2.	System boundary.....	119
C2.3.	Hydrogen Liquefaction Pathway .....	120
<b>Appendix C3: LOHCs as Hydrogen Carriers..... 123</b>		
C3.1.	LOHC Process Description .....	123
C3.2.	Output Metrics and System boundary .....	123
C3.3.	LOHC Production .....	124



## LIST OF FIGURES

FIGURE 1: STAGES OF HYDROGEN SUPPLY CHAIN.....	13
FIGURE 2: “WELL-TO-GATE” SYSTEM BOUNDARY ADOPTED FOR THIS DOCUMENT .....	29
FIGURE 3: “WELL-TO-GATE” SYSTEM BOUNDARY DIVIDED IN THREE SECTIONS (PRODUCTION, CONDITIONING AND TRANSPORT) .....	30
FIGURE 4: SCHEMATICS FOR COPRODUCED STEAM IN A SMR PROCESS .....	41
FIGURE 5: PROCESS DIAGRAM FOR THE UPSTREAM SYSTEM TO DELIVER THE NATURAL GAS FOR H <sub>2</sub> PRODUCTION .....	43
FIGURE 6: EXAMPLE OF AVOIDING ALLOCATION BY EXPANDING THE SYSTEM BOUNDARY .....	46
FIGURE P1. 1: PROCESS DIAGRAM FOR HYDROGEN PRODUCED FROM ELECTROLYSIS .....	51
FIGURE P2. 1: SMR PLANT WITHOUT CO <sub>2</sub> CAPTURE.....	54
FIGURE P2. 2: PROCESS DIAGRAM FOR HYDROGEN PRODUCED FROM SMR/CCS.....	55
FIGURE P3. 1: PROCESS DIAGRAM FOR HYDROGEN PRODUCED FROM CHLORALKALI PROCESS .....	62
FIGURE P3. 2: PROCESS DIAGRAM FOR HYDROGEN PRODUCED FROM STEAM CRACKING.....	63
FIGURE P3. 3: ENERGY DIAGRAM FOR THE CHLORALKALI PROCESS [SCHERPBIER AND EERENS, 2020].....	64
FIGURE P3.4: BREAKDOWN OF FUEL GAS (FG) .....	66
FIGURE P3.5: LIFE-CYCLE (WELL-TO-GATE) GREENHOUSE GAS EMISSIONS .....	67
FIGURE P4. 1: COAL GASIFICATION UPSTREAM SYSTEM.....	73
FIGURE P4. 2: COAL GASIFICATION SYSTEM.....	73
FIGURE P4. 3: COAL GASIFICATION PRODUCTION PATHWAY .....	75
FIGURE P4. 4: COAL GASIFICATION UPSTREAM SYSTEM.....	76
FIGURE P4.5: AIR SEPARATION SYSTEM .....	77
FIGURE P4.6: COAL GASIFICATION SYSTEM.....	79
FIGURE P5.1: HYDROGEN FROM BIOMASS - GENERAL OVERVIEW .....	86
FIGURE P5. 2: PROCESS DIAGRAM FOR THE UPSTREAM SYSTEM TO DELIVER BIOGAS MIXTURE FOR UPGRADING AND/OR REFORMING.....	87
FIGURE P5. 3: PROCESS DIAGRAM FOR HYDROGEN PRODUCED FROM SMR/CCS.....	88
FIGURE P5. 4: PROCESS DIAGRAM FOR HYDROGEN PRODUCED FROM DRY REFORMING/CCS .....	88
FIGURE P5. 5: PROCESS DIAGRAM FOR THE UPSTREAM SYSTEM TO PRETREAT WOOD TO WOOD CHIPS FOR GASIFICATION PROCESSES .....	90
FIGURE P5. 6: PRODUCTION SYSTEM BASED ON GASIFICATION, REFORMING, SHIFT AND PSA.....	90
FIGURE P5. 7: PRODUCTION SYSTEM BASED ON ABSORPTION ENHANCED REFORMING (AER) GASIFICATION, SHIFT REACTOR AND PSA .....	91
FIGURE P6. 1: DIAGRAM OF A TYPICAL ATR CONFIGURATION.....	98
FIGURE P6. 2: PROCESS DIAGRAM FOR HYDROGEN PRODUCED FROM ATR/CCS.....	99
FIGURE C1. 1: MODULES FOR LIFE CYCLE ANALYSIS OF AMMONIA .....	105
FIGURE C1. 2: EXAMPLE CONFIGURATION OF NATURAL GAS-BASED AMMONIA PRODUCTION FACILITY.....	106
FIGURE C1. 3: UPSTREAM EMISSIONS ASSOCIATED WITH AMMONIA PRODUCTION.....	107
FIGURE C1. 4: EXAMPLE CONFIGURATION OF AN AMMONIA PRODUCTION PLANT USING GASIFIERS.....	110
FIGURE C1. 5: AMMONIA PRODUCTION FROM HYDROGEN ADAPTED FROM LIU ET AL. <sup>4</sup> .....	113
FIGURE C1. 6: EXAMPLE PATHWAY FOR AMMONIA CRACKING TO PRODUCE LOW-CARBON HYDROGEN, ADAPTED FROM NUMEROUS SOURCES.” .....	116
FIGURE C2. 1: MODULES FOR LIFE CYCLE ANALYSIS OF HYDROGEN LIQUEFACTION .....	119
FIGURE C2. 2: CONFIGURATION OF CONVENTIONAL HYDROGEN LIQUEFACTION PLANTS BASED ON THE CLAUDE CYCLE.....	121

FIGURE C3. 1: MODULES FOR LIFE CYCLE ANALYSIS OF LOHCS ..... 124  
FIGURE C3. 2: EXAMPLE CONFIGURATION OF COMMON LOHC PRODUCTION PATHWAYS. .... 125  
FIGURE C3. 3: EXAMPLE CONFIGURATION OF DIRECT MCH PATHWAY. .... 125  
FIGURE C3. 4: EMISSIONS ASSOCIATED WITH LOHC CRACKING..... 128





## LIST OF TABLES

TABLE 1: TYPES OF ENVIRONMENTAL IMPACTS AND CHARACTERISTIC FACTORS.....	32
TABLE 2: GLOBAL WARMING POTENTIAL (GWP) OF VARIOUS GHGS [IPCC 2018].....	32
TABLE P1. 1: GHG EMISSIONS SUMMARY FOR ELECTROLYSIS .....	51
TABLE P2. 1: KEY LIFE CYCLE GHG EMISSION SOURCES IN H2 PRODUCTION FOR SMR /CCS.....	56
TABLE P3. 1: YIELD AND PRODUCT COMPOSITION OF A TYPICAL STEAM CRACKING PLANT.....	62
TABLE P3. 2: ELECTRICITY CONSUMPTION FOR THE PRODUCTION OF HYDROGEN FROM CHLORALKALI ELECTROLYSIS.....	65
TABLE P3. 3: RESULTS OF VARIOUS EMISSION ALLOCATION METHODS FOR HYDROGEN AS BY-PRODUCT FROM THE CHLORALKALI INDUSTRY.....	65
TABLE P3. 4: TYPICAL YIELD OF CO-PRODUCTS FROM FEEDSTOCK’S FOR STEAM CRACKING PROCESS (ACC, 2004). .....	67
TABLE P3. 5: MARKET VALUE-BASED ALLOCATION FOR HYDROGEN CO-PRODUCT FROM STEAM CRACKING BASED ON WONG AND VAN DRIL (2020) AND EUROPEAN CO-PRODUCT FROM BOULAMANTI AND MOYA (2017).....	68
TABLE P3. 6: RESULTS OF VARIOUS EMISSION ALLOCATION METHODS FOR BY-PRODUCT HYDROGEN FROM STEAM CRACKING. ....	68
TABLE P4. 1: GHG EMISSIONS SUMMARY FOR COAL GASIFICATION /CCS.....	74
TABLE P5. 1: GHG EMISSIONS SUMMARY FOR BIOMASS-BASED HYDROGEN ROUTES /CCUS .....	91
TABLE P6. 1: KEY LIFE CYCLE GHG EMISSION SOURCES IN H2 PRODUCTION BY ATR.....	100
TABLE C1. 1: KEY LIFE CYCLE GHG EMISSION SOURCES IN AMMONIA PRODUCTION FROM NATURAL GAS OR BIOGAS WITH CCS .....	107
TABLE C1. 2: POTENTIAL CO-PRODUCTS AND EMISSIONS ACCOUNTING FRAMEWORK FOR AMMONIA PRODUCTION FROM NATURAL GAS OR BIOGAS.....	108
TABLE C1. 3 INFORMATION TO BE REPORTED FOR REFORMING PATHWAY TO AMMONIA PRODUCTION.....	108
TABLE C1. 4 KEY EMISSIONS FROM AMMONIA PRODUCTION FROM GASIFIERS WITH CCS .....	111
TABLE C1. 5: POTENTIAL CO-PRODUCTS AND EMISSIONS ACCOUNTING FRAMEWORKS FOR AMMONIA PRODUCTION FROM GASIFIERS WITH CCS .....	112
TABLE C1. 6 INFORMATION TO BE REPORTED FOR GASIFICATION BASED AMMONIA PRODUCTION PATHWAY .	112
TABLE C1. 7: KEY EMISSIONS FROM AMMONIA PRODUCTION FROM CLEAN HYDROGEN .....	114
TABLE C1. 8: POTENTIAL CO-PRODUCTS AND EMISSIONS ACCOUNTING FRAMEWORK FOR AMMONIA PRODUCTION FROM CLEAN HYDROGEN .....	114
TABLE C1. 9 INFORMATION TO BE REPORTED FOR AMMONIA PRODUCTION.....	114
TABLE C1. 10: KEY EMISSION SOURCES ASSOCIATED WITH AMMONIA CRACKING .....	116
TABLE C1. 11: POTENTIAL CO-PRODUCTS ASSOCIATED WITH AMMONIA CRACKING .....	117
TABLE C1. 12: INFORMATION TO BE REPORTED FOR AMMONIA CRACKING.....	117
TABLE C2. 1: KEY EMISSION SOURCES IN HYDROGEN LIQUEFACTION .....	122
TABLE C2. 2: POTENTIAL CO-PRODUCTS AND EMISSIONS ACCOUNTING FRAMEWORK FOR HYDROGEN LIQUEFACTION .....	122
TABLE C3. 1: KEY LIFE CYCLE GHG EMISSION SOURCES IN LOHC MANUFACTURING.....	127
TABLE C3. 2: POTENTIAL CO-PRODUCTS AND EMISSIONS ACCOUNTING FRAMEWORK FOR HYDROGENATION .....	128
TABLE C3. 3: KEY LIFE CYCLE GHG EMISSION SOURCES IN LOHC DEHYDROGENATION/CRACKING.....	129

TABLE C3. 4: POTENTIAL CO-PRODUCTS AND EMISSIONS ACCOUNTING FRAMEWORK FOR DEHYDROGENATION .....	129
TABLE C3. 5: INFORMATION TO BE REPORTED FOR MCH OR PDBT PRODUCTION FACILITIES .....	129
TABLE C3. 6: INFORMATION TO BE REPORTED FOR MCH OR PDBT DEHYDROGENATION FACILITIES .....	130



## Disclaimer

This publication was developed under the framework of IPHE but does not necessarily reflect the views of individual IPHE member countries. The IPHE makes no representation or warranty, express or implied, with respect to the publication's contents (including its completeness or accuracy) and shall not be responsible for any use of, or reliance on, the publication.

IPHE is aware that this framework for emissions analysis is being requested by multiple governments particularly during a period when policy-makers, industry, and various stakeholders are considering hydrogen and other clean energy technologies to meet their climate goals as well as allocation of incentives and funding to accelerate deployments. Nothing in this report should be construed as an indication of future individual determinations regarding the appropriateness of any specific life cycle emissions methodologies for any specific purpose, including the choice of scope boundaries of such analyses. The analysis methodology described in this framework does not include all emissions that may be relevant for some determinations, and should be treated as first version available to be revised as analyses are updated, not a conclusion or direction of the IPHE, nor of its members.

## Acknowledgements

This document was prepared by an IPHE task force drawn from all interested IPHE members. The study was designed and directed by Laurent ANTONI (France), Sunita SATYAPAL (United States) and Tudor CONSTANTINESCU (European Commission).

The analysis and production of the report was coordinated by Laurent ANTONI (France), Rebecca THOMSON (Australia), Marcel WEEDA (The Netherlands). In addition, the main contributors were Prerna BHARGAVA (Australia) and Sam LAMBOO (The Netherlands).

The report benefited from valuable inputs, comments, and feedback from other experts within the IPHE, including: Dmitri BESSAROV (Republic of South Africa), Marco BUFFI (European Commission), Tasnim CHOUDHURY (United Kingdom), Fabio DOMANICO (European Commission), Amgad A. ELGOWAINY (United States), Tudor FLOREA (France), Ayaka JONES (USA), Ruud KEMPENER (European Commission), Bernd KUEPKER (European Commission), Yuki KUDOH (Japan), Hankwon LIM (Republic of Korea), Akiteru MARUTA (Japan), Marc MELAINA (United States), Neha RUSTAGI (United States), Ryo CHISHIRO (Japan), Nicolae SCARLAT (European Commission), Timothy SKONE (United States) and Aurelie WIELCHUDA (United Kingdom).

The analysis and production of the IPHE's Carriers chapter was led by Neha RUSTAGI (United States) and Rebecca THOMSON (Australia). In addition, other contributors include Amgad ELGOWAINY, Kriston BROOKS, Greg COONEY, Hanna BREUNIG, Matthew JAMIESON, and Zeric HULVEY (United States).

The report benefited from valuable inputs, comments, and feedback from other experts within the IPHE, including: Abdelmuti MURAD (United Arab Emirates), Akiteru MARUTA (Japan), Akin SADIKU (Canada), Aurelie WIELCHUDA (United Kingdom), Ben HARROP (United Kingdom), Bernd KUEPKER (European Commission), Camilo AVILES (Chile), Cosmas CHITEME (South Africa), Deepak SAKARIA (United Arab Emirates), Dmitri BESSARABOV (South Africa), Hendrik LOUW (South Africa), Ho Mu LEE (Republic of Korea), Hyejin LEE (Republic of Korea), Laurent ANTONI (France), Luisa BOLL (Germany), Marco BUFFI (European Commission), Mamahloko SENATLA (South Africa), Marcel WEEDA (The Netherlands), Marina DOMINGUES FERNANDES (Brazil), Mikako MIKI (Japan), Naser Al HAMMADI (United Arab Emirates), Nawal Al-HANAEE (United Arab Emirates), Nikolaos (Nikos) LYMPEROPOULOS (European Commission), Olumoye (Moye) AJAO (Canada), Prerna BHARGAVA (Australia), Reshika RAMDHANI (South Africa), Sam LAMBOO (The Netherlands), Ryo CHISHIRO (Japan), and Yuki KUDOH (Japan).

Many experts from outside the IPHE provided input, commented on the underlying analytical work, and reviewed the document. Their comments and suggestions were of great value.

## 1 Foreword

Hydrogen can be produced from diverse sources including renewables, nuclear and fossil fuels using carbon capture, utilization, and storage (CCUS) to reduce the emissions associated with its production. Hydrogen can be used to decarbonise numerous sectors including transportation, industrial manufacturing, and power generation. At the Hydrogen Energy Ministerial (HEM) meeting in 2019, Ministers encouraged actions in line with the four pillars in the Tokyo Statement, while taking into account different national circumstances. The versatility and storage capacity of hydrogen creates potential for domestic production and consumption of hydrogen and also as a tradeable energy commodity between countries. There is a need for harmonised regulation, codes, and standards (RCS) to facilitate the deployment of new and innovative technologies. Leading organizations including the International Partnership for Hydrogen and Fuel Cells in the Economy (IPHE), the International Energy Agency (IEA) and Clean Energy Ministerial (CEM) / Mission Innovation (MI) are taking actions on four main issues individually and collaboratively to scale up and accelerate the deployment of hydrogen technologies. This includes collaboration on technologies and harmonization of regulation, codes and standards, and the collection, analysis and sharing of data to evaluate the potential of hydrogen and its effect on CO<sub>2</sub> and other emissions reduction, both upstream and downstream across a variety of hydrogen production pathways.

To enable a robust and sustainable market for hydrogen technologies, it is necessary to develop clean, affordable, secure, and reliable supply chains to support the development of effective hydrogen trading markets. To this end, countries will need to put in place standards and protocols that are transparent and that facilitate efficient international trade in hydrogen. This will require international standards developed through the relevant international standards development bodies, facilitating the removal and/or reduction of regulatory barriers, and to help develop a common definition of clean/sustainable hydrogen.

During the 32<sup>nd</sup> IPHE Steering Committee in October 2019 in Seoul, South Korea, countries recognised that regulations currently limit the development of a clean hydrogen industry and that government and industry must work together to ensure existing regulations are not an unnecessary barrier to investment. A particular challenge is that identical hydrogen molecules can be produced and combined from sources with very different CO<sub>2</sub> intensities. Likewise hydrogen-based fuels and products be indistinguishable and might result from hydrogen being combined with a range of fossil and low-carbon inputs. Indeed, some of the products made from hydrogen (e.g. electricity) could themselves be used in the production of hydrogen. Accounting standards for different sources of hydrogen along the supply chain will be fundamental to creating a market for low-carbon hydrogen, and that these standards need to be agreed internationally. To this end, a Hydrogen Production Analysis Task Force (H2PA TF) has been created to propose a methodology and analytical framework to determine the GHG emissions related to a unit of produced hydrogen. It may serve as a basis of a certification scheme. However, it will not provide guidance on any GHG emissions intensity threshold values be proposed. This will remain the responsibility of each country even if common terminologies and thresholds will facilitate an international trade of hydrogen.

This methodology is based on the principles of

- inclusiveness (methodologies should not exclude any potential primary energy),
- flexibility (approaches must allow for unique circumstances and hence flexible),
- transparency (methodologies must be transparent in approach and assumptions to build confidence),
- comparability (approach should be comparable with the approach used by other technologies to help allow for 'apples to apples' comparisons on emissions) and
- practicality (methodologies must be practical, facilitating uptake by industry and use in the market).

The emergence of a hydrogen market needs to also increase public knowledge and acceptance. This includes to leverage the increasing demand of information and expectation from the society towards a carbon-neutral economy. In this context, the origin and GHG intensity of hydrogen are important parameters. To facilitate international trade and allow consumers/customers to choose their preferences, there is a need for a (maximum) harmonized international classification framework for hydrogen which includes information on sustainability criteria (e.g. origin, CO<sub>2</sub>-intensity, other emissions) across the full lifecycle, usually called from "cradle-to-grave", and which ensures traceability of the attributes.

**IPHE is open to considering this full lifecycle approach and calls to apply it for all energy vectors.** However, based on the previous principles, and in particular to ensure a fair comparability with the other energy vectors, this second version of methodology has kept the current commonly used system boundaries, usually called from "well-to-gate", excluding the emissions from the building of the capital goods (including hydrogen production devices, etc.). This second version of the IPHE guidance is addressing additional aspects, such as downstream emissions associated with hydrogen conditioning in different liquid forms. The next step will be to also address the transport and distribution of hydrogen, and emissions associated with manufacturing of goods.

## 2 Introduction

The H2PA task force aims to initiate a process by taking early steps to develop a mutually agreed upon methodology for determining the greenhouse gas emissions associated with the production of hydrogen up to the delivery gate. A key issue arising in this hydrogen deployment phase is the certification of CO<sub>2</sub>e intensity and origin of hydrogen supplies, as well as benchmarks for the incumbent processes they replace.

A mutually recognised, international framework is needed that is robust, avoids mislabelling or double counting of environmental impacts. The framework will provide a mutually agreed approach to "guaranties" or "certificates" of origin, and that covers greenhouse gas inputs to hydrogen-based fuels and feedstock's.

This document presents a methodology that will be built on over time and cover additional production processes where necessary and other parts of the value chain such as different hydrogen physical states and energy carriers, and emissions due to the transportation to the

usage gate. It may be this document may be used as a reference by a standard development organisation like ISO (e.g. ISO/TC 197 Hydrogen technologies and ISO/TC 207 Environmental management) to develop an international standard. However, as noted in the H2PA TF terms of reference, this document does not lead to any binding commitments or expectations on behalf of any country. The methodology serves as a reference with which each county can develop their own methodology by taking into account different national circumstances/regulatory framework.

### 3 Scope

There are numerous pathways to produce hydrogen from various primary energies. This document describes the requirements and evaluation methods applied to several hydrogen production pathways of interest: electrolysis, steam methane reforming (with carbon capture and storage), by-production and coal gasification (with carbon capture and storage). This second version includes two new production pathways: hydrogen from biomass and auto-thermal reforming (with carbon capture and storage). These are initial hydrogen production pathways considered by the IPHE H2PA TF. The Taskforce intends to develop analysis methods for other pathways in the future.

This second working document is considering the GHG emissions due to the conditioning of hydrogen in different carriers: 1) the production and cracking of ammonia as a hydrogen carrier, 2) hydrogen liquefaction, and 3) production and cracking of liquid organic hydrogen carriers (LOHCs).

The next version of this working document will complete the approach with the consideration of the GHG emissions due to hydrogen and/or hydrogen carriers' transportation up to the delivery gate.

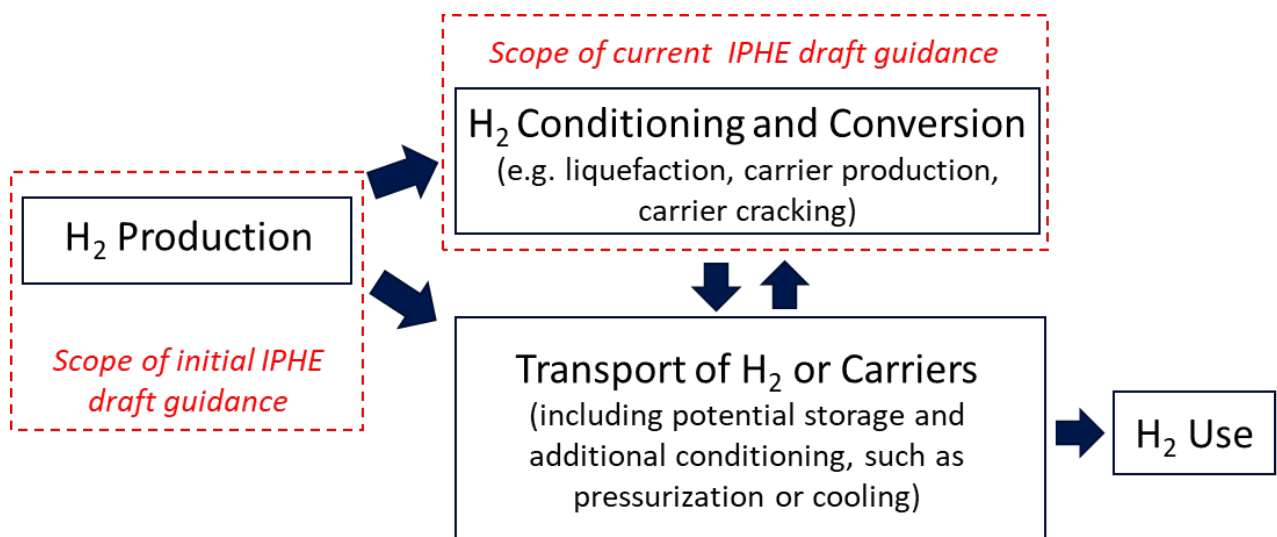

Figure 1: Stages of hydrogen supply chain

The current document describes best practices for analysis of hydrogen conditioning and conversion. Previous IPHE guidance described best practices for analysis of hydrogen production. In real-world deployments, the stages shown in this figure may occur in varying orders and some stages may repeat prior to hydrogen use, or may not occur at all.

This document applies to the evaluation of greenhouse gas emissions in the hydrogen production process in accordance with the life cycle assessment method.

## 4 Normative References

The following documents are referred to in the text in such a way that some or all of their content constitutes requirements of this document. For dated references, only the edition cited applies. For undated references, the latest edition of the referenced document (including any amendments) applies.

ISO 14040 Environmental Management Life Cycle Assessment Principles and Framework

ISO 14044 Environmental Management Life Cycle Assessment Requirements and Guidelines

ISO 14067 Greenhouse gases — Carbon footprint of products — Requirements and guidelines for quantification

GHG Protocol A Corporate Accounting and Reporting Standard. Revised Edition.

## 5 Terms and Definitions

The common terminology used for the different origins and methods of produced hydrogen investigated in this document is presented in this section. The terms and definitions used by various international organisations (e.g. IEC, ISO) have been adopted whenever possible.

### 5.1 Quantification of the Carbon Footprint of a Product

#### 5.1.1 Allocation

Partitioning the input or output flows of a process or a product system between the product system under study and one or more other product systems

[SOURCE: ISO 14040:2006]

*Note 1: Physical allocation can be applied when a physical, i.e. causal, relationship can be identified between the inputs, outputs and co-products of the multifunctional process. Such a relationship exists when the amounts of the co-products can be independently varied. How the amounts of inputs and outputs (emissions and waste) change following such a variation can be used to allocate the inputs and outputs to the varied co-product*



*Note 2: This allocation procedure is applicable when: a) the relative production of co-products can be independently varied through process management, and b) this has causal implications for the inputs required, emissions released or waste produced.*

*Note 3: inputs and outputs can also be allocated between co-products reflecting other relationships between them, e.g. in proportion to the economic value of co-products (economic allocation). The most common form of economic allocation is based on the revenue obtained from the co-products*

[SOURCE: ISO 14040:2006/AMD 1:2020]

### 5.1.2 Carbon Footprint of a Product, CFP

Sum of greenhouse gas emissions (5.1.13) and greenhouse gas removals in a product system (5.2.3), expressed as CO<sub>2</sub> equivalent (5.1.9) and based on a life cycle assessment (5.3.5) using the single impact category of climate change.

*Note 1 to entry: A CFP can be disaggregated into a set of figures identifying specific GHG emissions and removals (see **Table 1**). A CFP can also be disaggregated into the stages of the life cycle (5.3.4).*

*Note 2 to entry: The results of the quantification of the CFP are documented in the CFP study report expressed in mass of CO<sub>2</sub>e per functional unit (5.1.9).*

[SOURCE: ISO 14067:2018]

### 5.1.3 CFP Study

All activities that are necessary to quantify and report a *carbon footprint of a product* (5.1.2) or a *partial CFP*

[SOURCE: ISO 14067:2018]

### 5.1.4 Product Category

Group of products that can fulfil equivalent functions

[SOURCE: ISO 14025:2006, 3.12]

### 5.1.5 Production Batch

A production batch is the amount of H<sub>2</sub> produced by a registered device between any two points in time selected by the Operator for which the quantity of is calculated

### 5.1.6 Sub-Batch

A sub batch is the part of a production batch defined in accordance with production process specific calculation procedures

### 5.1.7 Quantification of CFP

Activities that result in the determination of a carbon footprint of a product (5.1.2) or a partial CFP

*Note 1 to entry: Quantification of the CFP or the partial CFP is part of the CFP study*

[SOURCE: ISO 14067:2018]

### 5.1.8 Greenhouse Gas, GHG

Gaseous constituent of the atmosphere, both natural and anthropogenic, that absorbs and emits radiation at specific wavelengths within the spectrum of infrared radiation emitted by the Earth's surface, the atmosphere and clouds

*Note 1 to entry: For a list of greenhouse gases, see the latest IPCC Assessment Report (currently carbon dioxide (CO<sub>2</sub>); methane (CH<sub>4</sub>); nitrous oxide (N<sub>2</sub>O))*

*Note 2 to entry: Water vapour and ozone, which are anthropogenic as well as natural greenhouse gases, are not included in the carbon footprint of a product ()*

*Note 3 to entry: The focus of this document is limited to long-lived GHGs and it therefore excludes climate effects due to changes in surface reflectivity (albedo) and short-lived radiative forcing agents (e.g. black carbon and aerosols).*

[SOURCE: ISO 14067:2018]

### 5.1.9 Carbon Dioxide Equivalent, CO<sub>2</sub> Equivalent, CO<sub>2</sub>e

Unit for comparing the radiative forcing of a greenhouse gas (5.1.8) to that of carbon dioxide

*Note 1 to entry: Mass of a greenhouse gas is converted into CO<sub>2</sub> equivalents by multiplying the mass of the greenhouse gas by the corresponding global warming potential (5.1.12) or global temperature change potential (GTP) of that gas.*

*Note 2 to entry: In the case of GTP, CO<sub>2</sub> equivalent is the unit for comparing the change in global mean surface temperature caused by a greenhouse gas to the temperature change caused by carbon dioxide.*

[SOURCE: ISO 14067:2018]

### 5.1.10 Emissions

The release of GHG into the atmosphere

[SOURCE: 2004 GHG protocol (Chapter 4)]

#### 5.1.11 Emission Factor

A factor allowing GHG emissions to be estimated from a unit of available activity data (e.g. tonnes of fuel consumed, tonnes of product produced) and absolute GHG emissions

[SOURCE: 2004 GHG protocol (Chapter 6)]

#### 5.1.12 Global Warming Potential, GWP

Index, based on radiative properties of greenhouse gases (GHG) (5.1.13), measuring the radiative forcing following a pulse emission of a unit mass of a given GHG in the present-day atmosphere integrated over a chosen time horizon, relative to that of carbon dioxide (CO<sub>2</sub>)

*Note 1 to entry: “Index” as used in this document is a “characterization factor” as defined in ISO 14040:2006, 3.37.*

Note 2 to entry: A “pulse emission” is an emission at one point in time.

[SOURCE: ISO 14067:2018]

#### 5.1.13 Greenhouse Gas Emission, GHG Emission

Release of a greenhouse gas (5.1.13) into the atmosphere

[SOURCE: ISO 14067:2018]

#### 5.1.14 Greenhouse Gas Emission Factor, GHG Emission Factor

Coefficient relating activity data with the greenhouse gas emission (5.1.13)

[SOURCE: ISO 14067:2018]

#### 5.1.15 GHG Protocol

An additional module of the GHG Protocol Initiative addressing the quantification of GHG Quantification Standard reduction projects. This includes projects that will be used to offset emissions elsewhere and/or generate credits. More information available at:

[www.GHGprotocol.org](http://www.GHGprotocol.org)

[SOURCE: 2004 GHG protocol (Chapters 8, 11)]

## 5.2 Products, Product Systems and Processes

### 5.2.1 Product

Any goods or service

*NOTE 1 The product can be categorized as follows:*

- *services (e.g. transport);*
- *software (e.g. computer program, dictionary);*
- *hardware (e.g. engine mechanical part);*
- *processed materials (e.g. lubricant).*

*NOTE 2 Services have tangible and intangible elements. Provision of a service can involve, for example, the following:*

- *an activity performed on a customer-supplied tangible product (e.g. automobile to be repaired);*
- *an activity performed on a customer-supplied intangible product (e.g. the income statement needed to prepare a tax return);*
- *the delivery of an intangible product (e.g. the delivery of information in the context of knowledge transmission);*
- *the creation of ambience for the customer (e.g. in hotels and restaurants).*

*Software consists of information and is generally intangible and can be in the form of approaches, transactions or procedures.*

*Hardware is generally tangible and its amount is a countable characteristic. Processed materials are generally tangible and their amount is a continuous characteristic.*

*NOTE 3 Adapted from ISO 14021:1999 and ISO 9000:2005.*

[SOURCE: ISO 14040:2006]

### 5.2.2 Product Flow

Products entering from or leaving to another product system

[SOURCE: ISO 14040:2006]

### 5.2.3 Product System

Collection of *unit processes* with *elementary flows* and product flows, performing one or more defined functions and which models the *life cycle* (5.3.4) of a *product*

[SOURCE: ISO 14044:2006, 3.28]

### 5.2.4 Co-Product

Two or more *products* coming from the same *unit process* or *product system* (5.2.3)

[SOURCE: ISO 14040:2006, 3.10]

### 5.2.5 Energy from Renewable Sources or Renewable Energy

Means energy from renewable non-fossil sources, namely wind, solar (solar thermal and solar photovoltaic) and geothermal energy, ambient energy, tide, wave and other ocean energy, hydropower, biomass, landfill gas, sewage treatment plant gas, and biogas;”

[SOURCE: DIRECTIVE (EU) 2018/2001]

### 5.2.6 Geothermal Energy

Means energy stored in the form of heat beneath the surface of solid earth

[SOURCE: DIRECTIVE (EU) 2018/2001]

### 5.2.7 Heating Value

The amount of energy released when a fuel is burned completely. Care must be taken not to confuse higher heating values (HHVs), used in the US and Canada, and lower heating values, used in other countries (for further details refer to the calculation tool for stationary combustion available at [www.GHGprotocol.org](http://www.GHGprotocol.org)).

[SOURCE: 2004 GHG protocol]

### 5.2.8 Input

Product, material or energy flow that enters a unit process

NOTE Products and materials include raw materials, intermediate products and co-products.

[SOURCE: ISO 14040:2006]

### 5.2.9 Intermediate Flow

Product, material or energy flow occurring between unit processes of the product system being studied

[SOURCE: ISO 14040:2006]

### 5.2.10 Intermediate Product

Output from a unit process that is input to other unit processes that require further transformation within the system

[SOURCE: ISO 14040:2006]

### 5.2.11 Output

Product, material or energy flow that leaves a unit process

NOTE Products and materials include raw materials, intermediate products, co-products and releases.

[SOURCE: ISO 14040:2006]

### 5.2.12 System Boundary

Boundary based on a set of criteria representing which *unit processes* are a part of the system under study

[SOURCE: ISO 14040:2006/AMD 1:2020]

### 5.2.13 System Expansion

The concept of expanding the product system to include additional functions related to the co-products can also be referred to as system expansion or expanding the system boundary

Note 1: the product system that is substituted by the co-product is integrated in the product system under study. In practice, the co-products are compared to other substitutable products, and the environmental burdens associated with the substituted product(s) are subtracted from the product system under study. The identification of this substituted system is done in the same way as the identification of the upstream system for intermediate product inputs. See also ISO/TR 14049:2012, 6.4

Note 2: The application of system expansion involves an understanding of the market for the co-products. Decisions about system expansion can be improved through understanding the way co-products compete with other products, as well as the effects of any product substitution upon production practices in the industries impacted by the co-products.

[SOURCE: ISO 14040:2006/AMD 1:2020]

### 5.2.14 Process

Set of interrelated or interacting activities that transforms inputs into outputs

[SOURCE: ISO 14044:2006]

### 5.2.15 Functional Unit

Quantified performance of a *product system* (5.2.3) for use as a reference unit

*Note 1 to entry: As the carbon footprint of a product treats information on a product basis, an additional calculation based on a declared unit can be presented (see also [6.3.3](#)).*

[SOURCE: ISO 14040:2006, 3.20]

### 5.2.16 Reference Flow

Measure of the inputs to or outputs from *processes* in a given *product system*) required to fulfil the function expressed by the functional unit

*Note 1 to entry: For an example of applying the concept of a reference flow, see the example in [6.3.3](#).*

*Note 2 to entry: In the case of a partial CFP, the reference flow refers to the declared unit.*

[SOURCE: ISO 14067:2018]

### 5.2.17 Elementary Flow

Material or energy entering the system being studied that has been drawn from the environment without previous human transformation, or material or energy leaving the system being studied that is released into the environment without subsequent human transformation

*Note 1 to entry: "Environment" is defined in ISO 14001:2015, 3.2.1.*

[SOURCE: ISO 14044:2006]

### 5.2.18 Energy Flow

Input to or output from a unit process or product system, quantified in energy units

Note: Energy flow that is an input can be called an energy input; energy flow that is an output can be called an energy output.

[SOURCE: ISO 14040:2006]

### 5.2.19 Functional Unit

Quantified performance of a product system for use as a reference unit

[SOURCE: ISO 14040:2006]

## 5.3 Life Cycle Assessment

### 5.3.1 Cut-Off Criteria

Specification of the amount of material or energy flow or the level of significance of *greenhouse gas emissions* (5.1.13) associated with *unit processes* or the *product system* (5.2.3) to be excluded from a *CFP study* (5.1.3)

*Note 1 to entry: "Energy flow" is defined in ISO 14040:2006, 3.13.*

[SOURCE: ISO 14067:2018]

### 5.3.2 Evaluation

Element within the life cycle interpretation phase intended to establish confidence in the results of the life cycle assessment

NOTE Evaluation includes completeness check, sensitivity check, consistency check, and any other validation that may be required according to the goal and scope definition of the study

[SOURCE: ISO 14040:2006]

### 5.3.3 Fugitive Emissions

Emissions that are not physically controlled but result from the intentional or unintentional releases of GHGs. They commonly arise from the production, processing transmission storage and use of fuels and other chemicals, often through joints, seals, packing, gaskets, etc.

[SOURCE: 2004 GHG protocol (Chapters 4,6)]

### 5.3.4 Life Cycle

Consecutive and interlinked stages related to a *product* (5.2.1), from raw material acquisition or generation from natural resources to end-of-life treatment

*Note 1 to entry: "Raw material" is defined in ISO 14040:2006, 3.15.*

*Note 2 to entry: Stages of a life cycle related to a product include raw material acquisition, production, distribution, use and end-of-life treatment.*

[SOURCE: ISO 14067:2018]

### 5.3.5 Life Cycle Assessment, LCA

Compilation and evaluation of the inputs, outputs and the potential environmental impacts of a *product system* (5.2.3) throughout its *life cycle* (5.3.4)

*Note 1 to entry: "Environmental impact" is defined in ISO 14001:2015, 3.2.4.*

[SOURCE: ISO 14044:2006, 3.2]

### 5.3.6 Life Cycle Inventory Analysis, LCI

Phase of *life cycle assessment* (5.3.5) involving the compilation and quantification of inputs and outputs for a *product* (5.2.1) throughout its *life cycle* (5.3.4)

[SOURCE: ISO 14044:2006, 3.3]

### 5.3.7 Location-Based Method

Uses the average emissions intensity of the electricity grid in the location in which energy consumption occurs.

[SOURCE: 2015 GHG protocol Scope 2 Guidance]

### 5.3.8 Market-Based Method

Uses the emissions intensity from choices a consumer makes regarding its electricity supplier or product. These choices (purchasing renewable energy certificates or differentiated electricity product) are reflected through contractual arrangements between the purchaser and the provider.

[SOURCE: 2015 GHG protocol Scope 2 Guidance]



### 5.3.9 Inventory

A quantified list of an organization's GHG emissions and sources.

[SOURCE: 2004 GHG protocol]

### 5.3.10 Leakage (Secondary Effect)

Leakage occurs when a project changes the availability or quantity of a product or service that results in changes in GHG emissions elsewhere

[SOURCE: 2004 GHG protocol (Chapter 8)]

### 5.3.11 Materiality Threshold

A concept employed in the process of verification. It is often used to determine whether an error or omission is a material discrepancy or not. It should not be viewed as a de minimus for defining a complete inventory

[SOURCE: 2004 GHG protocol (Chapter 10)]

### 5.3.12 Process Emissions

Emissions generated from manufacturing processes, such as the CO<sub>2</sub> that arises from the breakdown of calcium carbonate (CaCO<sub>3</sub>) during cement manufacture. (Chapter 4, Appendix D)

[SOURCE: 2004 GHG protocol (Chapter 4, Appendix D)]

### 5.3.13 Releases

Emissions to air and discharges to water and soil

[SOURCE: ISO 14040:2006]

### 5.3.14 Scope

Defines the operational boundaries in relation to indirect and direct GHG emissions

[SOURCE: 2004 GHG protocol (Chapter 4)]

### 5.3.15 Scope 1 Inventory

A reporting organization's direct GHG emissions

[SOURCE: 2004 GHG protocol (Chapter 4)]

### 5.3.16 Scope 2 Inventory

A reporting organization's emissions associated with the generation of electricity, heating/cooling, or steam purchased for own consumption

[SOURCE: 2004 GHG protocol (Chapter 4)]

### 5.3.17 Scope 3 Inventory

A reporting organization's indirect emissions other than those covered in scope 2

[SOURCE: 2004 GHG protocol (Chapter 4)]

### 5.3.18 Sensitivity Analysis

Systematic procedures for estimating the effects of the choices made regarding methods and data on the outcome of a *CFP study* (5.1.3)

[SOURCE: ISO/FDIS 14067:2018]

### 5.3.19 Sensitivity Check

Process to determine whether the information obtained from a sensitivity analysis is relevant for reaching the conclusions and for giving recommendations

[SOURCE: ISO 14040:2006 FDAM 1:2020]

### 5.3.20 Transparency

Open, comprehensive and understandable presentation of information

[SOURCE: ISO 14040:2006]

### 5.3.21 Uncertainty Analysis

Systematic procedure to quantify the uncertainty introduced in the results of a life cycle inventory analysis due to the cumulative effects of model imprecision, input uncertainty and data variability

*Note: Either ranges or probability distributions are used to determine uncertainty in the results.*

[SOURCE: ISO 14040:2006]

### 5.3.22 Waste

Substances or objects that the holder intends or is required to dispose of

*Note 1 to entry: This definition is taken from the Basel Convention on the Control of Transboundary Movements of Hazardous Wastes and Their Disposal (22 March 1989), but is not confined in this document to hazardous waste.*

[SOURCE: ISO 14040:2006, 3.35]

## 5.4 Organizations

### 5.4.1 Interested Party

Individual or group concerned with or affected by the environmental performance of a product system, or by the results of the life cycle assessment

[SOURCE: ISO 14040:2006]

### 5.4.2 Intergovernmental Panel on Climate Change (IPCC)

The Intergovernmental Panel on Climate Change (IPCC) is the international body for assessing the science related to climate change. The IPCC was set up in 1988 by the World Meteorological organization (WMO) and United Nations Environment Programme (UNEP) to provide policymakers with regular assessments of the scientific basis of climate change, its impacts and future risks, and options for adaptation and mitigation. ([www.ipcc.ch](http://www.ipcc.ch)).

[SOURCE: IPCC factsheet]

### 5.4.3 Organization

Person or group of people that has its own functions with responsibilities, authorities and relationships to achieve its objectives

*Note 1 to entry: The concept of organization includes, but is not limited to, sole-trader, company, corporation, firm, enterprise, authority, partnership, charity or institution, or part or combination thereof, whether incorporated or not, public or private.*

[SOURCE: ISO 14001:2015, 4]

## 5.5 Data and Data Quality

### 5.5.1 Data Quality

Characteristics of data that relate to their ability to satisfy stated requirements

[SOURCE: ISO 14040:2006]

### 5.5.2 Double Counting

Two or more reporting companies take ownership of the same emissions or reductions

[SOURCE: 2004 GHG protocol (Chapters 3, 4, 8, 11)]

### 5.5.3 Primary Data

Quantified value of a *process* (5.2.14) or an activity obtained from a direct measurement or a calculation based on direct measurements

*Note 1 to entry: Primary data need not necessarily originate from the product system under study because primary data might relate to a different but comparable product system to that being studied.*

*Note 2 to entry: Primary data can include greenhouse gas emission factors and/or greenhouse gas activity data (defined in ISO 14064-1:2006, 2.11).*

[SOURCE: ISO 14067:2018]

#### 5.5.4 Secondary Data

Data which do not fulfil the requirements for *primary data* (5.5.3)

*Note 1 to entry: Secondary data can include data from databases and published literature, default emission factors from national inventories, calculated data, estimates or other representative data, validated by competent authorities.*

*Note 2 to entry: Secondary data can include data obtained from proxy processes or estimates.*

[SOURCE: ISO 14067:2018]

#### 5.5.5 Site-Specific Data

Primary data obtained within the *product system*

*Note 1 to entry: All site-specific data are primary data but not all primary data are site-specific data because they may be obtained from a different product system.*

*Note 2 to entry: Site-specific data include greenhouse gas (GHG) emissions from GHG sources as well as GHG removals by GHG sinks for one specific unit process within a site.*

[SOURCE: ISO 14067:2018]

#### 5.5.6 Uncertainty

Parameter associated with the result of quantification that characterizes the dispersion of the values that could be reasonably attributed to the quantified amount

*Note 1 to entry: Uncertainty can include, for example:*

- *parameter uncertainty, e.g. greenhouse gas emission factors, activity data;*
- *scenario uncertainty, e.g. use stage scenario, end-of-life stage scenario;*
- *model uncertainty.*

*Note 2 to entry: Uncertainty information typically specifies quantitative estimates of the likely dispersion of values and a qualitative description of the likely causes of the dispersion.*

[SOURCE: ISO 14067:2018]

## 5.6 Abbreviated Terms

ATR	Auto Thermal Reforming
CCS	CO <sub>2</sub> Capture and Storage
CCU	CO <sub>2</sub> Capture and Utilisation
CFP	Carbon Footprint of a Product
CHP	Combined Heat and Power
CO <sub>2</sub> e	Carbon Dioxide Equivalent
DBT	Di Benzyl Toluene
GHG	Greenhouse Gas
GO	Guaranties of Origin
GWP	Global Warming Potential
IPCC	Intergovernmental Panel On Climate Change
IPHE	International Partnership for Hydrogen and fuels cells in the Economy
ISO	International Standardisation Organisation
LCA	Life Cycle Assessment
LCIA	Life Cycle Impact Assessment
LCI	Life Cycle Inventory Analysis
LHV	Low Heating Value
LOHC	Liquid Organic Hydrogen Carriers
MCH	Methyl Cyclo Hexane
MDEA	Mono-Diethanol Amine
MEA	Mono-Ethanol Amine
NG	Natural Gas
PDBT	Perhydro-DBT
PSA	Pressure Swing Adsorption
SMR	Steam Methane Reformer

## 6 Evaluation Methods

### 6.1 Evaluation Basis

The proposed emissions accounting methodology aims at being applied for all hydrogen production pathways utilising the different standards ISO 14067, ISO 14040, ISO 14044 and

the GHG protocols that represent a universally recognized methodology to study the carbon footprint (and other impacts) of fuel production.

Therefore, referring to ISO 14067, the following criteria shall be applied for the goal and scope definition phase:

- a. the product category definition and description of the investigated pathways are identical;
- b. the declared unit is identical;
- c. the system boundary is equivalent;
- d. the description of data is equivalent;
- e. the criteria for inclusion of inputs and outputs are equivalent;
- f. the data quality requirements (e.g. coverage, precision, completeness, representativeness, consistency and reproducibility) are the same;
- g. assumptions especially for the delivery stage are the same;
- h. specific GHG emissions and removals are treated identically;
- i. the units (described in Annexes) are identical;

The following criteria shall be applied for the life cycle inventory and LCIA phase:

- j. the methods of data collection and data quality requirements are equivalent;
- k. the calculation procedures are identical;
- l. the allocation of the flows is equivalent;
- m. the applied GWPs are identical.

## 6.2 Evaluation Scope

### 6.2.1 Product System Boundary

Analysis methods described in the current IPHE guidance cover a “well-to-gate” system boundary, including Scope 1, Scope 2, and partial Scope 3 emissions and excluding emissions deemed immaterial per Section 6.2.2.

Partial Scope 3 emissions considered include associated impacts from the raw material acquisition phase, raw material transportation phase, hydrogen production and manufacture. GHG contributions are defined in terms of carbon dioxide equivalent (CO<sub>2e</sub>)

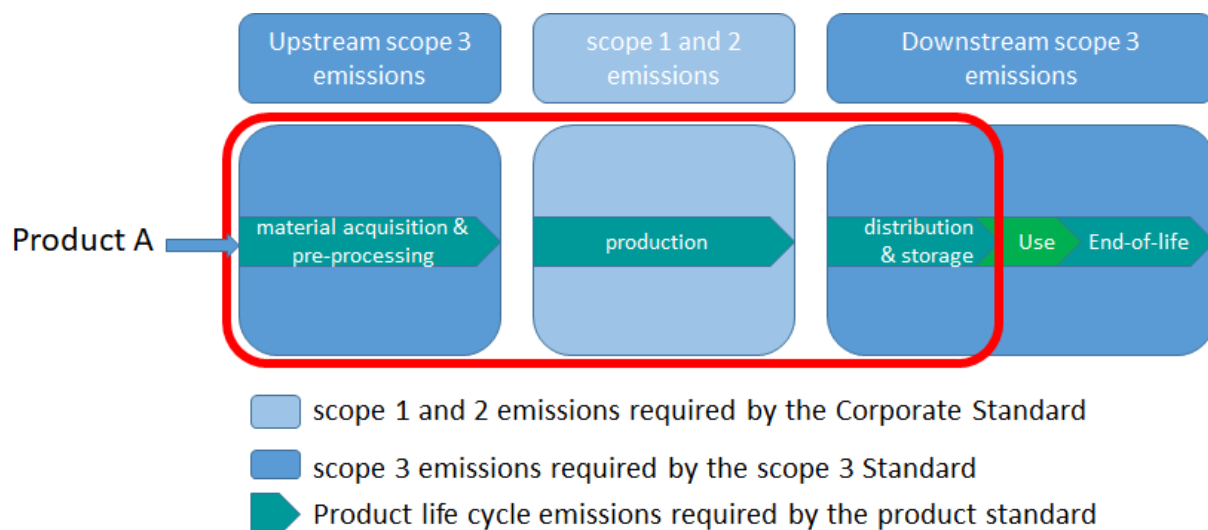

From Green House Gas protocol: product life cycle accounting and reporting standard – WBCSD, WRI

**Figure 2: “Well-to-Gate” system boundary adopted for this document**

The emissions from the construction, manufacturing, and decommissioning of the capital goods (including hydrogen production device, etc.), business travel, employee commuting and upstream leased assets are not considered. The rationale for this simplification was motivated by the comparatively small contribution that these emissions add to emissions associated with both fossil and renewable pathways,<sup>1</sup> and the fact that they are expected to decrease rapidly in the future,<sup>2,3,4,5</sup> due to effects of technological progress, and concurrent decarbonisation of upstream energy and material production, such as aluminium, clinker, copper or steel.

The “well-to-gate” system boundary is divided in three sections considering the hydrogen i) production ii) conditioning and iii) transportation as described in **Figure 3**.

<sup>1</sup> Pehl, M., Arvesen, A., Humpenöder, F., Popp, A., Hertwich, E. G., & Luderer, G. (2017). Understanding future emissions from low-carbon power systems by integration of life-cycle assessment and integrated energy modelling. *Nature Energy*, 2(12), 939–945. <https://doi.org/10.1038/s41560-017-0032-9>

<sup>2</sup> Pehl, M., Arvesen, A., Humpenöder, F., Popp, A., Hertwich, E. G., & Luderer, G. (2017). Understanding future emissions from low-carbon power systems by integration of life-cycle assessment and integrated energy modelling. *Nature Energy*, 2(12), 939–945. <https://doi.org/10.1038/s41560-017-0032-9>

<sup>3</sup> Hertwich, E. G., Gibon, T., Bouman, E. A., Arvesen, A., Suh, S., Heath, G. A., Shi, L. (2014). Integrated life-cycle assessment of electricity-supply scenarios confirms global environmental benefit of low-carbon technologies. *Proceedings of the National Academy of Sciences of the United States of America*. <https://doi.org/10.1073/pnas.1312753111>, [10.1073/pnas.1312753111](https://doi.org/10.1073/pnas.1312753111)

<sup>4</sup> Hydrogen decarbonisation pathways - A life-cycle assessment Hydrogen Council (2021)

<sup>5</sup> Assessment Report of the Intergovernmental Panel on Climate Change [Edenhofer, O., R. Pichs-Madruga, Y. Sokona, E. Farahani, S. Kadner, K. Seyboth, A. Adler, I. Baum, S. Brunner, P. Eickemeier, B. Kriemann, J. Savolainen, S. Schlömer, C. von Stechow, T. Zwickel and J.C. Minx (eds.)]. Cambridge University Press, Cambridge, United Kingdom and New York, NY, USA

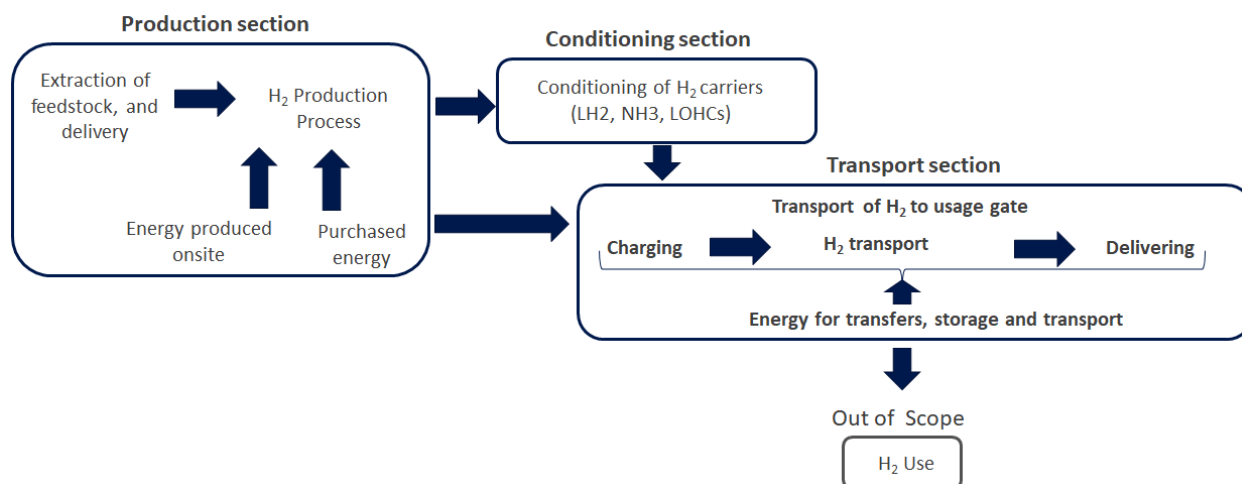

**Figure 3: “Well-to-Gate” system boundary divided in three sections (production, conditioning and transport)**

In the previous IPHE guidance, the functional unit for life cycle analysis of hydrogen production was established as 1 kilogram of hydrogen at 3 MPa<sup>6</sup> pressure (classical output pressure from the most used SMR production pathway) and 99% purity (an evaluation of GHG emission impact if moving to 99.9% or even 99.95% could be considered). Pressure and purity values were standardized within this functional unit to allow for consistent comparisons of different hydrogen production systems, regardless of how the hydrogen was subsequently distributed or used. If buffer storage is integrated with hydrogen production within the plant, then emissions associated energy consumption related to the operation of hydrogen storage facilities within the plant should be included.

In the current guidance, since the system boundary for analysis is being expanded beyond hydrogen production to include aspects of hydrogen transport, the functional unit is being revised. In the context of life cycle analyses that include multiple consecutive stages depicted in **Figure 3**, the functional unit for analysis of each stage is recommended to be 1 kilogram of hydrogen at a pressure and purity that corresponds to the inlet requirements of the subsequent stage. For example, if a life cycle analysis covers hydrogen conversion into a carrier and cracking followed by hydrogen transport, analysis of the cracking stage should use a functional unit with pressure and purity requirements that correspond to the inlet requirements for the transport stage.

The reporting metric recommended for life cycle analysis in the current guidance is kgCO<sub>2</sub>e/kgH<sub>2</sub>. The kgCO<sub>2</sub>e parameter is defined to be consistent with section 6.2.3 of the IPHE guidance published in 2021, titled “Methodology for Determining the Greenhouse Gas Emissions Associated with the Production of Hydrogen”.<sup>7</sup>

<sup>6</sup> For technologies whose typical hydrogen output pressure at gate is 1 MPa or lower, one can also report GHG emission at 1 MPa in addition to the GHG emission at 3 MPa. Calculation result of GHG emission adjusted to 3 MPa will require additional energy to compress the output pressure to 3 MPa using the same electricity emission factor as in 6.3.3.2.1.

<sup>7</sup> [https://www.iphe.net/files/ugd/45185a\\_ef588ba32fc54e0eb57b0b7444cfa5f9.pdf](https://www.iphe.net/files/ugd/45185a_ef588ba32fc54e0eb57b0b7444cfa5f9.pdf)



There are many process routes for hydrogen production, and different processes and methods are being proposed and implemented. This document gives the evaluation principles, system boundaries and expected reported metrics for six main routes. Appendixes P.1 to P.6 present the system boundaries of typical hydrogen production methods in hydrogen production from electrolysis of water, hydrogen production from steam reforming of natural gas with CCS, hydrogen production from industrial by-products and hydrogen production from coal gasification with CCS, hydrogen production from biomass, hydrogen production from auto-thermal reforming of natural gas with CCS.

Emissions associated with hydrogen infrastructure past the hydrogen production gate (e.g. liquefaction, hydrogenation in a carrier) is considered in a second section. The upstream boundary limit for the conditioning section is the downstream boundary limit for the previous production section. The downstream boundary limit is in this case the point of conditioning. Appendixes C.1 to C.3 present the system boundaries of typical hydrogen conditioning methods C.1) ammonia production and cracking, C.2) Hydrogen liquefaction and C.3) production and cracking of liquid organic hydrogen carriers.

Emissions associated with hydrogen transportation up to a delivery point will be considered in a future version of the document.

### 6.2.2 Selected Cut-Off Criteria

In general, efforts shall be taken to include all processes and flows that are attributable to the analysed system. Completeness based on environmental significance should be tested by including and excluding processes in the system boundary to determine if results change<sup>8</sup>.

If individual material or energy flows are found to be insignificant for a particular unit process, these may be excluded and shall be reported as data exclusions considering that if the actual data is known, then it should be included and not considered for exclusion. The cut-off criteria used to exclude certain processes of minor importance shall be clearly and consistently defined within the goal and scope definition phase.

Cut-off criteria for exclusion from analysis include:

- (1) uncertainty of the measurement equipment;
- (2) if regular and/or on-line measurements are unavailable, use proxy data derived from the open literature and applicable to the H<sub>2</sub> production location;

The final sensitivity analysis of the inputs and outputs data shall include the mass, energy and environmental (expressed in CO<sub>2e</sub>/kg<sub>H2</sub>) significance criteria so that all inputs not considered in the study must be reported.

---

<sup>8</sup> Testing for completeness based on environmental relevance is defined by ISO 14044 to be based on three criteria: mass, energy and environmental significance.

### 6.2.3 Evaluation Elements

The life cycle assessment of GHG emissions of produced hydrogen selects the impact of climate change as the evaluation element. The characteristic factors are shown in the following table.

**Table 1: Types of environmental impacts and characteristic factors**

Environmental impact type	Characterization model	Unit
Climate change	Global warming potential (GWP100)	kgCO <sub>2</sub> e

Greenhouse gases considered in this study are carbon dioxide (CO<sub>2</sub>), methane (CH<sub>4</sub>), and nitrous oxide (N<sub>2</sub>O)<sup>9</sup>. The global warming potential (GWP) of the various greenhouse gases is expressed in CO<sub>2</sub>e.

**Table 2** shows the GWP for a period of 100 years according to the Fifth Assessment Reports of the Intergovernmental Panel on Climate Change (IPCC).

**Table 2: Global warming potential (GWP) of various GHGs [IPCC 2018]**

	AR5 CO <sub>2</sub> e (g/g)
CO <sub>2</sub>	1
CH <sub>4</sub>	28
N <sub>2</sub> O	265

Following the product system boundaries, the energy requirements and GHG emissions resulting from the construction and decommissioning of manufacturing plants are not considered here. Furthermore, energy requirements and emissions resulting from the manufacturing and decommissioning of installations or applications (e.g. vehicles) consuming the hydrogen are not considered.

GHG impact of electricity used for H<sub>2</sub> production shall be restricted to Scope 1 and 2 emissions, and partial Scope 3 assumptions (not including emissions associated with manufacturing of power generation facilities). As a result of this assumption, the GHG impact of electricity generation from wind, solar photovoltaic, hydropower and geothermal will be assumed to be zero<sup>10</sup>.

### 6.2.4 Evaluation Cycle

The hydrogen considered should be evaluated with hydrogen produced in an industrial plant as the object.

<sup>9</sup> Other greenhouse gases are e.g. CFCs, HFCs, and SF<sub>6</sub>, which are, however, not relevant in this context

<sup>10</sup> There are some countries as e.g. Japan, whose electricity from wind, solar photovoltaic, hydropower and geothermal represent avoided emissions compared with average national grid emissions. In these cases, GHG impacts are not considered as zero so that the residual mix concept is not applicable.

The evaluation cycle for data is the considered time period of hydrogen production for which the quantified figure for the GHG emissions are representative. The time period for which the GHG emissions are representative shall be specified and justified.

All GHG emissions and removals shall be calculated, at least yearly, as if released or removed at the beginning of the assessment period without taking into account an effect of delayed GHG emissions and removals.

The choice of the time period for data collection should consider intra- and inter-annual variability and, when possible, use values representing the trend over the selected period. Where the GHG emissions and removals associated with specific unit processes within the life cycle of a product vary over time, data shall be collected over a time period appropriate to establish the average GHG emissions and removals associated with the life cycle of the product.

### 6.3 Life Cycle Impact Assessment

The process, methods and requirements of hydrogen life cycle impact assessment refer to ISO 14044.

A description of the following items is given for a hydrogen pathway.

- hydrogen process overview and description: production, conditioning (transport in a next version)
- emissions accounting method
- emissions inventory
- energy supply
- embodied emissions relating to the upstream extraction of resources
- emissions allocation
- results of sensitivity analyses and uncertainty assessments
- results of the life cycle interpretation, including conclusions and limitations
- disclosure and justification of value choices that have been made in the context of decisions within the study
- description of the stages of the life cycle, including a description of the selected use profiles when applicable
- assessment of influence of alternative use profiles on the final results
- time period for which the partial carbon footprint is representative
- reference used in the study.

#### 6.3.1 Description of Data

The methodology should use data that reduces bias and uncertainty by using the best quality data available. Data quality shall be characterized by both quantitative and qualitative aspects. Characterization should address the following:

- a. time-related coverage: age of data and the minimum length of time over which data should be collected;

- b. geographical coverage: geographical area from which data for unit processes should be collected to satisfy the goal of the partial carbon footprint study;
- c. technology coverage: specific technology or technology mix;
- d. precision: measure of the variability of each data value expressed (e.g. variance);
- e. completeness: percentage of total flow that is measured or estimated;
- f. representativeness: qualitative assessment of the degree to which the data set reflects the true population of interest (i.e. geographical coverage, time period and technology coverage);
- g. consistency: qualitative assessment of whether or not the study methodology is applied uniformly to the various components of the sensitivity analysis;
- h. reproducibility: qualitative assessment of the extent to which information about the methodology and data values would allow an independent practitioner to reproduce the results reported in the partial carbon footprint study;
- i. sources of the data;
- j. uncertainty of the information.

### 6.3.2 Emissions Accounting

An overview of the GHG emissions accounting methodology applied to each pathways is summarised below.

Total GHG emissions will be described following **Figure 3** as:

$$E_{\text{total emissions inventory}} = E_{\text{emissions inventory production}} + E_{\text{emissions inventory conditioning}} + E_{\text{emissions inventory transportation}}$$

Emissions include all Scope 1 and 2 and partial Scope 3 emissions arising in the “well-to-gate” boundary as defined in section 6.2.1. Carbon capture storage removals are defined in accordance with IPCC guidelines (not applicable for electrolysis).

Emissions of co-products are either discretely measured or accounted for through another means (see Section 6.3.3.4). In case of Carbon Capture and Utilization (CCU), CO<sub>2</sub> is considered as a co-product. However, there is currently no consensus between governments and between industrials if CO<sub>2</sub> allocation has to remain to the CO<sub>2</sub> producer or transferred to the CO<sub>2</sub> user. **Therefore in this version of the document, CO<sub>2</sub> is not to be considered as a co-product.**

The final accounted emissions will be the total emissions subtracted by the CCS removals and the emissions accounted to the co-products.

### 6.3.3 Emissions Inventory

The equation below shows the breakdown of the emissions inventory into its components (emissions categories). Individual countries may use their own emissions inventory that aligns with IPCC guidelines.

$$E_{\text{emissions inventory}} = E_{\text{combustion emissions}} + E_{\text{fugitive emissions}} + E_{\text{industrial process emissions}} + E_{\text{energy supply emissions}} + E_{\text{embodied emissions}}$$

### 6.3.3.1 Combustion Emissions

This source refers to the combustion of relevant solid, liquid and/or gaseous fuels including (but not limited to) coal, diesel and natural gas. Combustion emissions can be estimated via a variety of approaches including use of emission factors and measurement of fuel (volumetric or gravimetric), and direct measurement.

Combustion emissions should be calculated as follows:

$$E_{\text{combustion}} = \sum_i E_{\text{combustion},i}$$

Where  $E_{\text{combustion}}$  is the sum of emissions of carbon dioxide, methane and nitrous oxide (as applicable), released from the combustion of fuel type (i) within the module measured and converted in CO<sub>2</sub>e. This covers combustion of solid, liquid, and gaseous fuels calculated using a variety of methods.

### 6.3.3.2 Fugitive Emissions

This source intends all structural and operational losses due to the technology deployed and plant management respectively. Therefore, leakages and accidental losses, as well as other losses due to not-correct managing plant operations, are considered fugitive emissions.

Fugitive emissions should be calculated as follows:

$$E_{\text{fugitive}} = \sum_i E_{\text{fugitive},i}$$

Where  $E_{\text{fugitive}}$  is the sum of structural and operational emissions of carbon dioxide, methane and nitrous oxide (as applicable), released from fugitives of source type (i) within the module measured in CO<sub>2</sub>e.

For coal mining, this includes underground and open cut mines and emissions from coal extraction and flaring of coal mine waste gas. However, consistent with the well-to-gate system boundary, activities associated with the decommissioning of the facility (fugitives associated with post-mining activities) should be excluded.

As for most hydrogen producers, fossil fuels are provided by a third party, fugitive emissions associated to its transmission and distribution are captured by embodied emissions.

### 6.3.3.3 Industrial Process Emissions

Refers to emissions of specific GHG gases used across a number of industry activities (e.g. hydrofluorocarbons (HFCs) used in industrial refrigeration and/or cooling systems, and sulphur hexafluoride (SF6) used in electrical switchgear). For the purposes of this methodology, this is expected to be limited to emissions of CH<sub>4</sub> and N<sub>2</sub>O.

There are a variety of approaches that may be employed to estimate these emissions. Typically this might be via assumed leakage rates, or changes in stock levels of the relevant substances as measured throughout the relevant batch period. These items are expected to be extremely minor sources, and estimation should be sufficient in most cases.

Industrial process emissions should be calculated as follows:

$$E_{\text{industrial process emissions}} = \sum_i E_{\text{industrial process emissions},i}$$

Where  $E_{\text{industrial process emissions}}$  is the sum of emissions of relevant GHG (as applicable), released from industrial process activity (i) within the module measured in CO<sub>2e</sub> tonnes.

#### 6.3.3.4 Energy Supply

For the location-based emissions accounting approach, energy supply emissions should be calculated as follows:

$$E_{\text{energy supply emissions,location}} = \sum_i E_{\text{energy supply emissions},i}$$

Where  $E_{\text{energy supply emissions,location}}$  is the emissions of carbon dioxide, methane and nitrous oxide (as applicable), associated with supply of energy (i) within the module measured in CO<sub>2e</sub> tonnes (calculated in line with the location-based approach).

For the market-based emissions accounting approach, net energy supply emissions should be calculated as follows:

$$E_{\text{net energy supply emissions,market}} = \sum_i E_{\text{energy supply emissions},i} - E_{\text{applicable renewable energy}}$$

Where:

- $E_{\text{energy supply emissions,market}}$  is the emissions of carbon dioxide, methane and nitrous oxide (as applicable), associated with supply of energy (i) within the module measured in CO<sub>2e</sub> tonnes (calculated in line with the market-based electricity approach);
- $E_{\text{applicable renewable energy}}$  is the emissions associated with the supply of energy (in MWh) for which relevant renewable energy certificates have been purchased and retired.

##### 6.3.3.4.1 Treatment of Electricity

The GHG emissions associated with the **use** of electricity shall include:

- GHG emissions arising from the life cycle of the electricity supply system, such as upstream emissions (e.g. the mining and transport of fuel to the electricity generator or the growing and processing of biomass for use as a fuel). Following the product system boundaries, emissions associated with capital equipment manufacturing, construction and decommissioning are excluded in this version;
- GHG emissions during generation of electricity, including losses from electricity generation process and from transmission and distribution.

#### a) On-site electricity generation (scope 1 emissions)

When electricity is internally generated (e.g. on-site generated electricity) and consumed for the investigated hydrogen production process and no contractual instruments have been sold to a third party, then the emissions would be any scope 1 emissions resulting from generating that electricity.

Following the product system boundaries, Scope 1 emissions from electricity use are considered to be zero if on-site renewable electricity is used.

b) Electricity from the grid (scope 2 emissions)

A GHG emission factor obtained from the organization's supplier for the consumed electricity may be used if there is a dedicated transmission line between the organization and the generation plant from which the GHG emission factor is derived, and no contractual instruments have been sold to a third party for that consumed electricity.

The GHG electricity emissions should refer to electricity consumed by the plant, considering upstream emissions, operational and downstream emissions and all losses in electricity generation facility and transmission and distribution losses.

The electricity emissions reporting method proposed is consistent with the GHG protocol. This approach includes dual reporting requirements consisting of a location-based and market-based method.

- The location-based method to depict emissions with reference to the average emissions from the relevant regional grid at the time of the production measured in hours<sup>11</sup>;
- The market-based method to depict a businesses' emissions with reference to its renewable energy investments, such as power purchase agreements (PPA) or purchase of renewable energy certificates. This approach enables businesses to reduce their scope 2 emissions through contractual arrangements for renewable energy;
- Market-based data will be used where possible to calculate emissions-intensity of hydrogen production;
- If a market-based method is used, and the structure of regional regulations or renewable energy markets create potential for double counting of renewable energy between the market-based and location-based approaches, then a *residual mix factor* should be applied to the residual electricity that is not covered by contractual arrangements<sup>12</sup>;
- the residual mix factor may be country specific or average location-based grid emissions;
- all contractual instruments used in the market-based method must meet the scope 2 quality criteria listed in the GHG Protocol Scope 2 Guidance (Table 7.1, page 60)<sup>13</sup>.

A **residual mix factor** is applied to depict the emissions intensity of electricity consumed that is not covered by contractual arrangements. This factor will vary by country and potentially within regions of the same country, depending on how contracts for renewable energy are implemented. If the renewable energy a hydrogen producer consumes via contractual arrangements (e.g. renewable electricity credits or PPA) is not represented in the regional

---

<sup>11</sup> Location-based method – uses the average emissions intensity of the electricity grid in the location in which energy consumption occurs.

<sup>12</sup> Double counting could occur if the same unit of renewable energy is sold to a hydrogen producer via contractual arrangements (e.g. renewable energy credits) and also accounted for in the renewable content of the regional grid. To mitigate double counting in such situations, if a hydrogen producer is using the market-based method, a residual mix factor should be used to depict the emissions intensity of the regional grid.

<sup>13</sup> GHG protocol Scope 2 Guidance (2015)

[https://ghgprotocol.org/sites/default/files/standards/Scope%20%20Guidance\\_Final\\_Sept26.pdf](https://ghgprotocol.org/sites/default/files/standards/Scope%20%20Guidance_Final_Sept26.pdf)

grid emissions factor, then the residual mix factor can just represent the emissions factor of the grid. If, however, renewable energy being consumed by contracts is represented in the regional grid factor, then the residual mix factor must mitigate double counting. The manner in which this factor is calculated will vary based on the region and its associated regulations.

Consumers who do not make specified purchases should use the residual mix factor to calculate their market-based total.

In case of electricity import, a distinction between renewable and non-renewable electricity may be made. For the non-renewable electricity, the emission factor from the export country has to be used.

For the location-based approach, the quantity of electricity consumed is multiplied by the average grid emission factor, in kilograms of CO<sub>2</sub>e emissions per kilowatt hour, for the region in which the consumption occurs. State or province level grid factors are preferred but country level grid factors may also be applied if State or province factors are not available.

#### 6.3.3.4.2 Treatment of Steam

The steam involved in different processes can be used either as a heat input (e.g. to ensure the required temperature within different sub processes) or as a feedstock (e.g. high temperature electrolysis or gas reforming).

The steam may be provided either through a direct connection with a steam generation facility (either on site or outside of the hydrogen production facility), or through a steam supply network.

The origin of the steam may also vary: from a boiler (electric or thermal through combustion), from a combined heat and power (CHP) facility or from any other source of thermal energy (e.g.: geothermal, waste heat from industrial processes). In the latter case, the GHG emissions of the thermal energy used to generate the steam for the hydrogen facility cannot be determined other than on case-by-case basis, depending on its origin (e.g. primary energy used) and all the purposes that it serves. Given the large number of the possibilities, this edition will only treat the first two origins, the last one being work in progress.

In case of a steam supply network, the specific enthalpy of steam is the same all across the network (since the pressure and temperature are the same within the network), thus the share of steam equals the mass flowrate of the steam from a given energy source divided by the overall mass of steam flowing in that network. However, as any energy infrastructure, the supply steam network exhibits losses (thermal losses and pressure drop). These losses may be computed beforehand or measured. For the sake of the example, a 10% value could be considered to account for these losses.

The consistency of the measurement units must be checked at all times. Usually the steam parameters are its mass flowrate, temperature and pressure. The last two are used to determine the specific enthalpy of the steam and of the feed water (or any other thermodynamic property, such as density or entropy). The specific enthalpy of the steam and



feed water may be computed either from steam tables, or by using dedicated software (stand-alone or online), or by using the formulas that served to draw the steam tables and for the software. In any case, the literature is more than abundant; however, the source must be duly referenced. The enthalpy difference is the energy used to generate steam.

Coming back to the measurement units, the product of mass flowrate and specific enthalpy difference give power units (Watt). In order to obtain energy units (Joule or Watthour), a time period is needed. This may be the second, the hour, the day, the month, the yearly quarter or the year.

Calculation of the steam's GHG emissions

### **Steam from a boiler**

$$E_{\text{Steam}}(\text{kg}_{\text{CO}_2\text{e}}) = (\text{consumption}_{\text{fuel}} \times \text{emission factor}_{\text{fuel}}) + (\text{energy consumption}_{\text{electricity}} \times \text{emission factor}_{\text{electricity}})$$

With:

*consumption<sub>fuel</sub>*: the total amount of fuel consumption (Unit L) to produce the steam;

*emission factor<sub>fuel</sub>*: the CO<sub>2</sub>e emission factor of the fuel considered (kgCO<sub>2</sub>e / unit<sub>fuel</sub>).

### **Steam from CHP**

A CHP plant has a heat source, usually a boiler, a thermal engine or a gas turbine.

In case of a boiler, the CHP relies on steam cycle. Thus, the boiler generates all the steam. One possibility is that a part of the steam from boiler is supplied to other consumers and the rest will flow towards the steam turbine that generates the mechanical energy needed to make the power generator run. Another possibility is that all the steam goes to the steam turbine, which has intermediary outlets in order to extract steam at specific pressure and temperature, which is then supplied to the steam users. Any other combination is possible between these two configurations, including recovery heat at the condenser of the steam power cycle.

If the source heat is a thermal engine or a gas turbine, then the steam is generated from the exhaust gas through a heat exchanger.

Whatever the CHP technology, the GHG emissions for the steam may be determined as follows, provided that the energy needed for the CHP is self-provided, i.e., there is no other output than steam and power<sup>14</sup>, and the parameters of the steam and the amount of electricity generated by the CHP are measured<sup>15</sup>:

$$E_{\text{Steam}}(\text{kg}_{\text{CO}_2\text{e}}) = \text{share}_{\text{steam}} \times (\text{consumption}_{\text{fuel}} \times \text{emission factor}_{\text{fuel}} + E_{\text{operation}})$$

<sup>14</sup> For example in the case of a solid biomass fired CHP plant, the bottom ash may be sold as fertilizer, in which case it must be considered for the GHG allocation, besides the heat and power

<sup>15</sup> otherwise, the rated steam and electricity outputs may be used, but the measurements should be preferred

with:

$$\begin{aligned} share_{steam} &= \frac{\Delta Enthalpy_{steam}(T,P)}{Useful_{fuel,LHV}} \\ &= \frac{mass\ flowrate_{steam} \times Specific\ Enthalpy_{steam}(T,P)}{Useful_{fuel,LHV}} \end{aligned}$$

and:

$$Useful_{fuel,LHV} = \Delta Enthalpy_{steam}(T,P) + electrical\ energy$$

$E_{operation}$  (kgCO<sub>2</sub>e) is the GHG emissions from operation of CHP (e.g. the water supply and flue gas treatment).

For information purpose, the share of electricity is:

$$share_{electricity} = \frac{electrical\ energy}{Useful_{fuel,LHV}}$$

### **Steam coproduced using the heat flowing out of the reformer**

Where steam as an output of the process is valorized, emissions associated with the production of the steam that is on-sold can be deducted from the total emissions intensity of the hydrogen produced. The proposed emissions calculation for the steam is to divide the production processes into sub-processes and collecting the input and output data to assess the emissions generated to produce the steam.

The mixture of hydrogen and carbon dioxide flowing out of the reformer is at the reforming pressure and temperature<sup>16</sup>. The enthalpy difference of the mixture can be used to generate steam (or hot water). In order to allocate the GHG emissions to this steam (or hot water), a mass and enthalpy balance over the reformer is needed. This allows to track down the source of the GHG. **Figure 4** below illustrates the comprehensive case where the overall process includes:

- $Steam_1$ , first steam stream (steam for consumers outside the SMR unit),
- $Steam_{feed}$ , second steam stream to feed the reformer at reforming temperature<sup>17</sup>,
- $\Delta H_{NG,feed}$ , heat to bring the natural gas feeding (NG, feed) the reformer at the reforming temperature<sup>18</sup>,
- $\Delta H_{reaction}$ , heat to compensate for the heat sink of the reforming reaction,
- $Steam_2$ , third steam stream (for consumers outside the SMR unit) generated by the heat of the hydrogen-carbon dioxide mixture flowing out of the reformer<sup>19</sup>.

---

<sup>16</sup> 800 °C to 900 °C and 20 to 30 bar

<sup>17</sup> The pressure of the steam is ensured by the water feed pump

<sup>18</sup> The pressure of the natural gas is ensured by decompressing the gas from the gas grid (around 80 bar) to the reformer pressure (20 to 30 bar).

<sup>19</sup> The excess steam in the syngas is supposed to be condensed and the resulting water fed back into the process. The condensation heat is used to preheat the water (and/or combustion air, NG, etc.). Thus, the syngas considered here is H<sub>2</sub> + CO<sub>2</sub>, with traces of CO and NG.

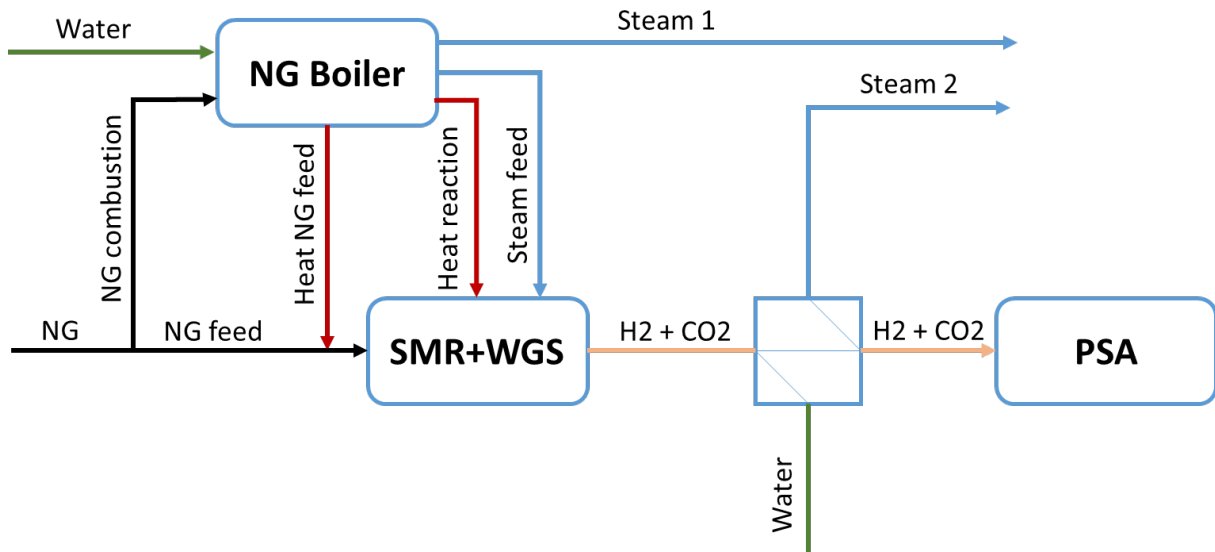

Figure 4: Schematics for coproduced steam in a SMR process<sup>20</sup>

The total useful enthalpy difference resulting for the natural gas combustion in the boiler is:

$$\Delta H_{Useful} = \Delta H_{Steam_1} + \Delta H_{Steam_{feed}} + \Delta H_{NG_{feed}} + \Delta H_{reaction}$$

Then the corresponding shares are:

$$share_{Steam_1} = \frac{\Delta H_{Steam_1}}{\Delta H_{Useful}}$$

$$share_{Steam_{feed}} = \frac{\Delta H_{Steam_{feed}}}{\Delta H_{Useful}}$$

$$share_{NG_{feed}} = \frac{\Delta H_{NG_{feed}}}{\Delta H_{Useful}}$$

$$share_{reaction} = \frac{\Delta H_{reaction}}{\Delta H_{Useful}}$$

These shares apply to  $GHG_{in}$ , which stands for the GHG emissions corresponding to the water (used for  $Steam_1$  and  $Steam_{feed}$ ), to the natural gas used for combustion and the emissions resulting from combustion.

The enthalpy balance over the SMR reads:

$$\Delta H_{Steam_{feed}} + \Delta H_{NG_{feed}} + \Delta H_{reaction} = \Delta H_{(H_2+CO_2)}^{SMR} + \Delta H_{reaction}$$

<sup>20</sup> The process may be further detailed into steam reformer and water gas shift reactor

Which gives the enthalpy difference of the hydrogen-carbon dioxide mixture flowing out of the reformer:

$$\Delta H_{(H_2+CO_2)}^{SMR} = \Delta H_{Steam_{feed}} + \Delta H_{NG_{feed}}$$

This may also be computed or derived from available tables, software or formulas in literature.

Whereas the enthalpy difference of the hydrogen-carbon dioxide mixture flowing in the PSA ( $\Delta H_{(H_2+CO_2)}^{PSA}$ ) is computed (from tables, software, formulas<sup>21</sup>) at the inlet temperature and pressure of the PSA.

The shares for the  $Steam_2$  and for the hydrogen and carbon dioxide mixture are:

$$share_{steam_2} = \frac{\Delta H_{Steam_2}}{\Delta H_{Steam_2} + \Delta H_{(H_2+CO_2)}^{PSA}}$$

$$share_{(H_2+CO_2)} = \frac{\Delta H_{(H_2+CO_2)}^{PSA}}{\Delta H_{Steam_2} + \Delta H_{(H_2+CO_2)}^{PSA}}$$

Finally, they are applied to the  $GHG_{in}$  plus GHG emissions corresponding to the natural gas used for reforming, plus the carbon dioxide resulting from the natural gas reforming ( $GHG_{SMR}$ ), plus GHG emissions corresponding to the water used for  $Steam_2$  ( $GHG_{water,2}$ ):

$$GHG_{Steam_2} = \left( share_{Steam_{feed}} + share_{NG_{feed}} + share_{reaction} \right) \times GHG_{in} + share_{Steam_2} \times GHG_{SMR} + GHG_{water,2}$$

And

$$GHG_{(H_2+CO_2)} = \left( share_{Steam_{feed}} + share_{NG_{feed}} + share_{reaction} \right) \times GHG_{in} + share_{(H_2+CO_2)} \times GHG_{SMR}$$

#### 6.3.3.4.3 Treatment of natural gas

Depending on the available data, calculation of the emission factor of the used gas (as energy or feedstock) ( $kgCO_2e / MWh_{LHV}$ ) for the different pathways considered can be performed by:

1. using a well-documented emission factor of the gas purchased or if not available
2. developing the upstream part of the production pathway overview as described below.

<sup>21</sup> The tables, software or formulas are available in literature, which provides also the reference conditions for which they are valid.

In locations where a Guaranty of Origin (GO) of gas is implemented, the emission factor of the natural gas consumed shall be calculated from the emission factor of the gas injected into the grid for which GOs were cancelled, or otherwise, the emission factor of the residual mix. GHG emissions from gas transport to consumption gate need to be added.

Where no GO scheme is implemented, the emission factor of the natural gas consumed shall be calculated from the average GHG emissions of the natural gas injected in the two preceding calendar years into the country grid from which the gas is obtained.

In any case, leakages from extraction gate to consumption gate have to be taken into account.

### Upstream system of a Hydrogen production pathway using natural gas

It covers upstream activities associated with the extraction, processing and delivery of the natural gas feedstock. Potential co-products from the gas extraction and processing steps include natural gas liquids such as ethane, propane, butane and pentane, as well as oil and condensates. These products often co-exist with the gas extracted from the reservoir and are typically separated out from the gas stream as they attract a higher value when sold as separate products.

System expansion is not feasible for this application as an appropriate alternative method for producing these products does not exist. Therefore, allocation will be performed for these co-products based on the proportion of energy content of the individual products.

The net remaining emissions are carried with the gas product stream (as embodied emissions) into the hydrogen production pathway considered.

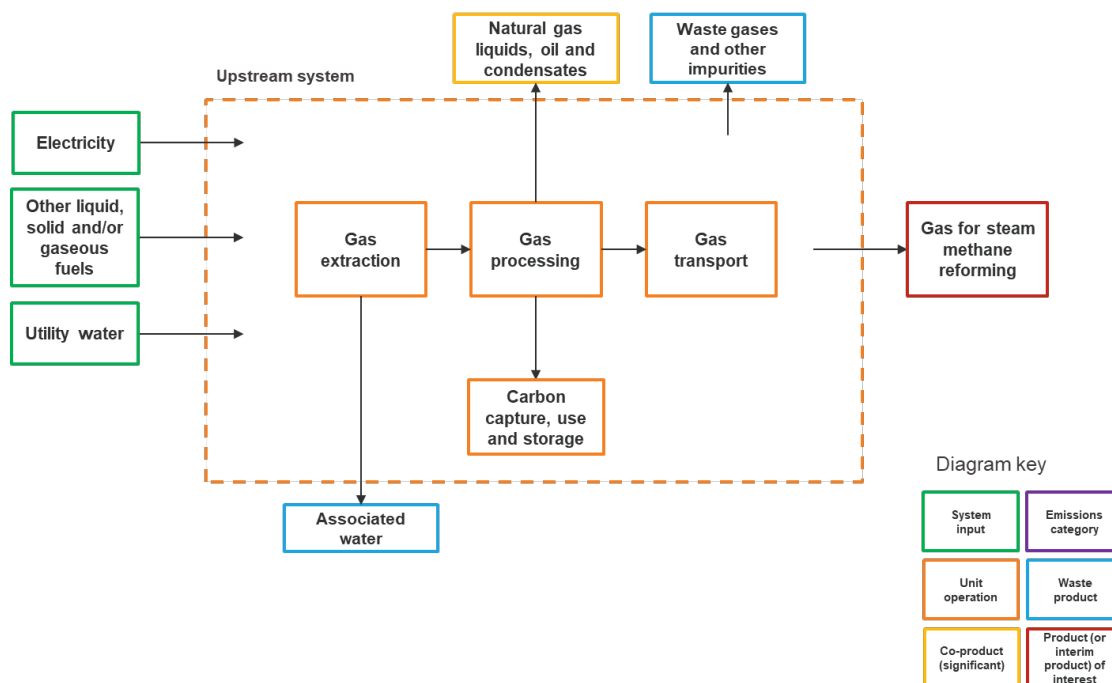

**Figure 5: Process diagram for the upstream system to deliver the natural gas for H<sub>2</sub> production**

### 6.3.3.5 Embodied Emissions

Embodied emissions (other than the energy supply emissions covered above) refers to upstream emissions associated with any input to a system. This could include key inputs such as coal, oxygen and natural gas. Additional input streams may be considered on an as needed basis, pending materiality. This could include items such as salts used for electrolysis and chemicals used for water treatment.

All processing associated with system water supply is assumed to occur within the facility boundaries and thus all emissions associated with this stream should be captured<sup>22</sup>.

Where multiple modules are considered, the emissions associated with the output or intermediate product of this module are associated with embodied emissions which should be carried into subsequent module(s).

The overall calculation for estimation of embodied emissions is as follows:

$$E_{\text{embodied emissions}} = \sum_i E_{\text{embodied emissions},i}$$

Where  $E_{\text{embodied emissions}}$  is the emissions of carbon dioxide, methane and nitrous oxide (as applicable), associated with input (i) within the module measured in CO<sub>2</sub>e tonnes.

### 6.3.3.6 Emissions Allocation

Production pathways for hydrogen always result in various waste products, by-products and co-products.

ISO 14044 and the GHG Protocol Standard distinguish between the product which is being studied as part of the GHG inventory preparation and other co-product(s) which “have value as an input into another product’s life cycle” (GHG Protocol, 2011). Consequently, the total emissions resulting from the hydrogen production should be separated between the hydrogen and the number of co-products where these products are valorised (on-sold). This allocation refers to the partitioning of the inputs or outputs of a process or product system between the product system under study and one or more other product systems. Waste products have no emissions allocated and by-products are assumed as co-products in terms of GHGs allocation criteria.

ISO 14044 states that allocation may be avoided by expanding the product system to include the additional functions related to the co-products. ISO 14044;2006/AMD 2:2020, Annex D document describes allocation procedures. There is no priority given between system expansion and physical allocation. The strengths and weaknesses of each one is described. There are some risks with the system expansion approach if not properly defined and implemented which could lead to some unintended consequences. For instance, in case of electricity as co-product, the use of system expansion approach can result in a broad range of

---

<sup>22</sup> Where water supply has been treated/processed upstream emissions for this supply should be considered in building the emissions inventory.

values for the emissions-intensity attributed to hydrogen, based on the emission intensity of the local grid (which may vary significantly between regions and countries).

Where allocation cannot be avoided, the inputs and outputs of the system should be partitioned between its different products or functions in a way that reflects the underlying physical relationships between them. As discussed in section 6.3.3.4.1, physical allocation could be performed on a mass basis or energy content basis. Energy is the most applicable to hydrogen production due to its high energy to mass ratio.

The methods for each production pathway will include specific guidance on the allocation approach to be used for each product. Allocation procedures shall be uniformly applied to similar inputs and outputs of the product system under consideration. The sum of the allocated inputs and outputs of a unit process shall be equal to the inputs and outputs of the unit process before allocation.

The procedures to manage coproducts for the shared unit processes should use the following order if feasible:

- Allocation based on Energy content (using frequently the Low Heating Values) physical allocation);
- Allocation based on System expansion;
- Allocation based on Economic value.

#### 6.3.3.6.1 Energy Content (Physical Allocation)

Physical allocation can be applied when a physical, i.e. causal, relationship can be identified between the inputs, outputs and co-products of the multifunctional process. Such a relationship exists when the amounts of the co-products can be independently varied. How the amounts of inputs and outputs (emissions and waste) change following such a variation can be used to allocate the inputs and outputs to the varied co-product.

This allocation procedure (step 2, 4.3.4.2 of ISO 14044) is applicable when:

a) the relative production of co-products can be independently varied through process management, and

b) this has causal implications for the inputs required, emissions released or waste produced. Physical allocation is based on physical constants, resulting in allocation, meaning the allocation factors that are relatively stable. But in many cases, physical allocation needs a deep insight into the process shared with other product systems. For co-products with significantly different economic values, physical allocation will not always properly reflect the intention to operate the process. Sometimes results based on physical allocations lead to interpretations that are disconnected from the business reality. When there is limited capacity to independently vary the production of co-products, the physical allocation procedure can have limitations. Allocation on a mass basis is problematic for hydrogen production as hydrogen has a high energy to mass ratio compared to the other co-products. This approach is therefore not recommended as a priority.

Allocation on the basis of energy content (using frequently the Low Heating Values) (the amount of useful energy contained in each co-product) could be suitable in many instances as hydrogen is an energy product. However not all co-products contain useful LHV (such as oxygen, chlorine) and in this case LHV content would not be a meaningful basis for allocation and another method could be used.

#### 6.3.3.6.2 System Expansion with Displacement

Expanding the product system to include additional functions related to the co-products (see 4.3.4.2, step 1, option 2 of ISO 14044) can be a means of avoiding allocation.

In the system expansion method, co-products are considered alternatives to other products on the market and can be assigned the same environmental burden as the alternative product. Therefore, the alternative product system that is substituted for the co-product is integrated in the product system under study. In practice, the co-products are compared to other substitutable products, and the environmental burdens associated with the substituted product(s) are subtracted from the product system under study (see **Figure 6**). The identification of this substituted system is done in the same way as the identification of the upstream system for intermediate product inputs.

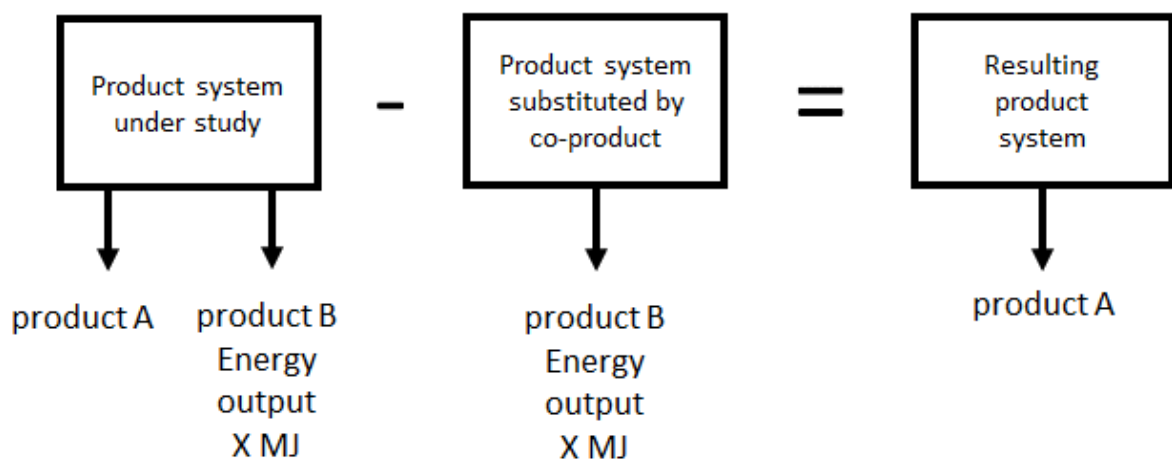

**Figure 6: Example of avoiding allocation by expanding the system boundary** <sup>23</sup>

The application of system expansion involves an understanding of the market for the co-products. Decisions about system expansion can be improved through understanding the way co-products compete with other products, as well as the effects of any product substitution upon production practices in the industries impacted by the co-products.

Important considerations relating to the identification of product systems substituted by co-products include whether:

- specific markets and technologies are affected;

<sup>23</sup> ISO 14044:2006 / FDAM 2:2020<sup>24</sup> ISO/TS 14071 Environmental management — Life cycle assessment — Critical review processes and reviewer competencies: Additional requirements and guidelines to ISO 14044:2006



- the production volume of the studied product systems fluctuates in time;
- a specific unit process is affected directly.

If applicable, when the inputs are delivered through a market, it is also important to know:

- whether any of the processes or technologies supplying the market are constrained, in which case their output does not change in spite of changes in demand;
- which of the unconstrained suppliers/technologies has the highest or lowest production costs and, therefore, is the supplier/technology affected when the demand for the supplementary product is generally decreasing or increasing, respectively.

The justification of the choice of system expansion can be based on technical considerations. System expansion can often be a straightforward choice for energy products. But where there are multiple industrial pathways for co-products, the model results can have high variability. If there are different possibilities of system expansion, it can lead to significantly different results. It is not always straightforward to identify. Therefore, the substitute systems for each co-product where system expansion is used have been precisely defined. This will ensure that, for a particular co-product, all hydrogen producers use the same substitute system.

It is not always straightforward to identify the products that are assumed to be substituted by the co-products of the multifunctional process. If there are no alternative production processes for a co-product, then system expansion is difficult to treat the multifunctional process and another means of allocation has been identified.

#### 6.3.3.6.3 Economic Value

According to 4.3.4.2, step 3 of ISO 14044, inputs and outputs can also be allocated between co-products reflecting other relationships between them, e.g. in proportion to the economic value of co-products (economic allocation).

The most common form of economic allocation is based on the revenue obtained from the co-products.

Economic allocation can reflect the intention of operating a process. The relative revenues can in some situations be seen as the ultimate causes for the production to take place. Economic allocation can help to reflect differences between regions and markets for similar products. Economic allocation has the potential to differentiate between similar products having different quality attributes. But market prices often vary with time, and between different regions and market actors. The selection of the allocation factors represents a value choice and the allocation factor can show a high uncertainty, especially for future scenarios. The application of economic allocation depends on having market prices for all co-products at the process of co-production. In general, a cost- or revenue-allocated product system will therefore not reflect the physical causalities of producing or purchasing a specific product. Therefore, economic allocation is only used when energy allocation or system expansion cannot be applied.

## 6.4 Life Cycle Assessment Report

After completing the life cycle impact assessment, the applicant should prepare a life cycle assessment report. The content of the report refers to ISO 14044.

# 7 Evaluation Process

## 7.1 Application

The applicant shall submit a formal verification application to the public service platform recognized by the national energy authority.

## 7.2 Document Verification

The public service platform may entrust a third-party verification agency to review the documents provided by the applicant unit in accordance with the requirements of this document<sup>24</sup>.

## 7.3 On-Site Verification

After completing the document verification, the verification agency shall conduct on-site verification based on this document and the documents submitted by the applicant. The on-site verification period is up to the verification agency but has to take place at least after any changes in the process or feedstock.

### 7.3.1 Document Verification and Submission Materials

- a) A scanned copy of the application unit's business license;
- b) The hydrogen production flow chart of the application unit;
- c) The main equipment list for hydrogen production;
- d) The life cycle of hydrogen production Evaluation report;
- e) List of raw materials for hydrogen production and their associated GHGs emissions;
- f) Energy/mass flow diagram;
- g) Energy metering system diagram;
- h) If hydrogen production facilities and equipment involve multiple locations, a list of production locations, processes, and processes of each facility should be submitted. Production date and production capacity information;
- i) Where other units apply for hydrogen evaluation for hydrogen production units, the relationship between the parties and the use of hydrogen evaluation shall be explained.

---

<sup>24</sup> ISO/TS 14071 Environmental management — Life cycle assessment — Critical review processes and reviewer competencies: Additional requirements and guidelines to ISO 14044:2006

## 7.4 On-Site Verification Steps

- a) Site visits and surveys;
- b) Confirm the input and output information of the product system boundary and unit process;
- c) Confirm the completeness and standardization of the data collection plan and data collection process;
- d) Check on-site data and time. The accuracy of the level data and the consistency of the data source;
- e) Check whether the content of the hydrogen life cycle assessment report meets the requirements of this document, and whether the information is correct;
- f) On-site verification of hydrogen parameters produced by hydrogen production projects, such as hydrogen purity, hydrogen pressure, hydrogen production, etc. Hydrogen production projects should have equipment to measure these hydrogen parameters and have a calibration certificate within the validity period.

## 8 Evaluation Conclusion

After completing the document verification and on-site verification in accordance with the requirements of this standard, the verification agency shall issue the evaluation conclusion.

## Appendix P1 Hydrogen Production Pathway - Electrolysis

There are currently three main electrolyser technologies, distinguished by the electrolyte (and associated production temperatures): alkaline electrolyser (ALK), polymer electrolyte membrane (PEM) electrolyser and solid oxide (SOEC) electrolyser. This methodology may be applied to any other electrolysis technologies.

### P1.1. Electrolysis Process Description

A water electrolysis cell consists of an anode and a cathode separated by a membrane immersed in an electrolyte (a conductive solution). When connected to a direct current power supply, electricity flows through the electrolyte and causes the water to split into hydrogen and oxygen. Each electrolyser system consists of a stack of electrolysis units, a gas purifier and dryer and an apparatus for heat removal.

Hydrogen and oxygen gas products must be purified, dried and cooled prior to storage and/or delivery to market, subject to required product specifications.

The oxygen gas must be safely vented to the atmosphere. Alternatively, pending availability of appropriate markets, this oxygen may be sold as a co-product.

Within this emissions accounting framework, electrolyzers are assumed to have an outlet pressure of 3 MPa<sup>25</sup>. Depending on the design of the electrolyzer, an electrolysis system may require compression to achieve 3 MPa pressure or drying. In that case, energy consumption for achieving this and the associated emission have to be calculated and included.

---

<sup>25</sup> For technologies whose typical hydrogen output pressure at gate is 1 MPa or lower, one can also report in addition to the 3 MPa, GHG emission at 1 MPa with the calculation result of GHG emission adjusted to 3 MPa which requires additional energy to increase the output pressure.

## P1.2. Electrolysis Overview

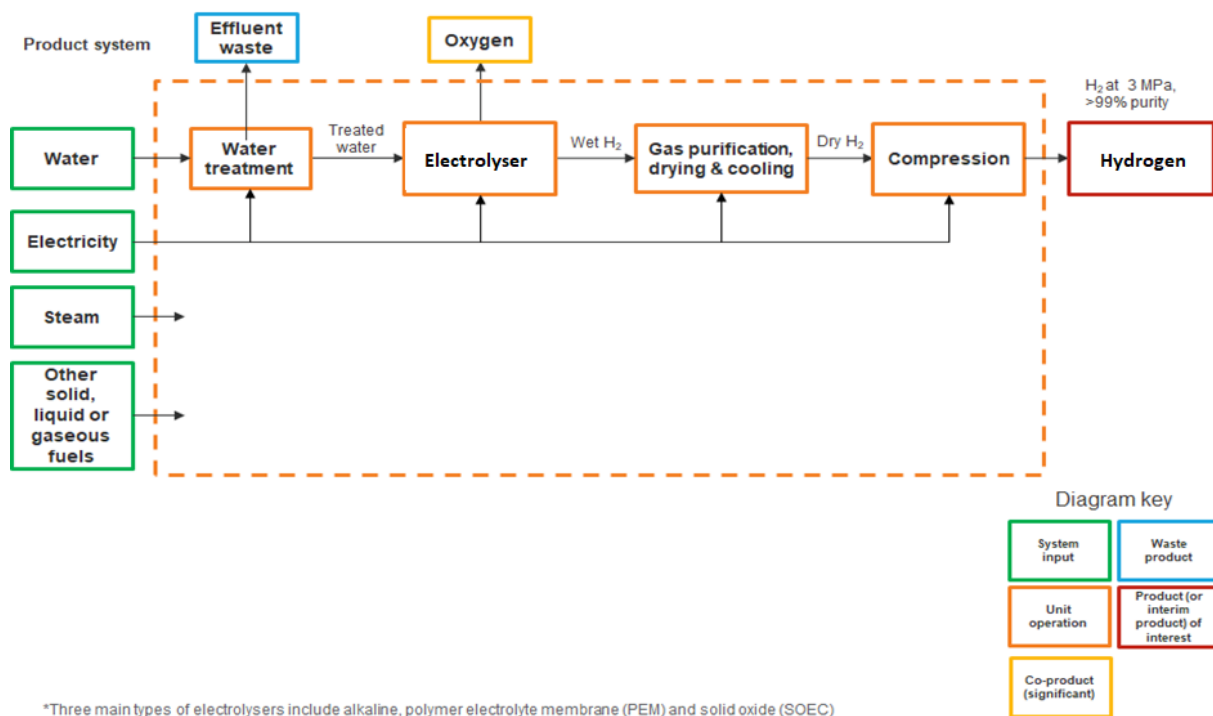

Figure P1. 1: Process diagram for hydrogen produced from electrolysis

## P1.3. Emissions Sources in Electrolysis

GHG emissions associated with electrolysis are subject to the nature of electricity supply for electrolysis as electricity can be sourced from the grid (noting that this may be impacted by contracting of renewable electricity supply and associated instruments), generated on-site via the combustion of liquid, gaseous and/or solid fuels (in this case, this would be the key emissions source) or supplied from an off-grid on-site system.

Each process unit or stage in the electrolysis process contains emissions sources outlined in **Table P1. 1**.

Table P1. 1: GHG emissions summary for electrolysis

Process unit/stage	Key emissions sources	Other emissions sources
Water supply and treatment	Electricity for purification and filtration	
Hydrogen production	Electricity for electrolyser units	Steam (where purchased) <sup>26</sup> Liquid, solid and/or gaseous fuel combustion for steam generation <sup>27</sup>

<sup>26</sup> Where high temperature SOEC are utilized

<sup>27</sup> Where high temperature SOEC are utilized

		Liquid, solid and/or gaseous fuel combustion for electricity generation <sup>28</sup>
Hydrogen compression, purification, drying and cooling	Electricity for relevant units	Steam (where purchased) Solid, liquid and/or gaseous fuel combustion for relevant units and/or steam generation

#### P1.4. Allocation for the electrolysis pathway

Electrolysis system can be analysed as a single module (see **Figure P1. 1** with one co-product, oxygen that can be readily handled using prioritised coproduct management strategies (see Section 6.3.3.4). (i.e. system expansion). Energy allocation is not appropriate for this co-product, as oxygen does not have an energy content and zero emissions would be allocated to it using this method. Therefore, the use of system expansion is recommended for this co-product. Cryogenic distillation system is suggested as a substitute system for producing oxygen (the most common process for producing oxygen). This system separates air into oxygen, nitrogen and argon. Emissions associated with the oxygen product stream can be estimated referring to the air separation model established within the Ecoinvent life cycle database. These emissions may then be readily removed from the inventory if oxygen is sold to the market.

#### P1.5. Information to be reported<sup>29</sup>

Category	Matters to be identified
Facility details	<ul style="list-style-type: none"> <li>• Facility identity</li> <li>• Facility location</li> <li>• Facility capacity</li> <li>• Commencement of facility operation</li> </ul>
Production	<ul style="list-style-type: none"> <li>• Production pathway</li> </ul>
Product specification	<ul style="list-style-type: none"> <li>• Hydrogen produced (kg)</li> <li>• Hydrogen pressure level at gate</li> <li>• Hydrogen purity level at gate</li> <li>• Specification of contaminants</li> </ul>
GHG emissions overview	<ul style="list-style-type: none"> <li>• Emissions intensity of hydrogen batch</li> </ul>
Batch details	<ul style="list-style-type: none"> <li>• Beginning and end of batch dates</li> <li>• Batch quantity</li> </ul>
Electricity	<p>Location based emissions accounting:</p> <ul style="list-style-type: none"> <li>• Quantity of purchased grid electricity [kWh]</li> <li>• Location based emission factor used [kgCO<sub>2</sub>e/kWh]</li> </ul> <p>Market based emissions accounting</p> <ul style="list-style-type: none"> <li>• Quantity of purchased grid electricity [kWh]</li> <li>• Quantity of contracted renewable electricity [kWh] and/or quantity of associated GOs or RECs</li> <li>• Type of GOs or RECs</li> </ul>

<sup>28</sup> Where on-site electricity generation is non-renewable

<sup>29</sup> In a country where GO system and residual mix system are not used for electricity emission counting, reporting of GO and residual mix related matters cannot be necessary.

	<ul style="list-style-type: none"> <li>• Residual electricity</li> <li>• Residual mix emission factor [kgCO<sub>2</sub>e/kWh]</li> </ul> <p>On-site electricity generation</p> <ul style="list-style-type: none"> <li>• Quantity of on-site generation [kWh]</li> <li>• Emission factor for on-site generation (as applicable) [kgCO<sub>2</sub>e/kWh]</li> </ul>
Other utilities	<ul style="list-style-type: none"> <li>• Source/s of water</li> <li>• Source/s of steam</li> <li>• Quantity of purchased water [kg]</li> <li>• Quantity of purchased steam [kg]</li> <li>• Quantity of steam exported [kg]</li> </ul>
Fuel feedstock	<ul style="list-style-type: none"> <li>• Types of fuels combusted</li> <li>• Quantities of fuel combusted [L, kg]</li> <li>• Relevant emissions calculations and factors used</li> </ul>
Process	<ul style="list-style-type: none"> <li>• Water treatment technology</li> <li>• Electrolyser technology</li> <li>• Hydrogen purification technology</li> </ul>
Water feedstock	<ul style="list-style-type: none"> <li>• Water source/s</li> <li>• Quantity of water used [kg]</li> </ul>
Waste and/or co-products	<ul style="list-style-type: none"> <li>• Quantity of oxygen produced [kg]</li> <li>• Quantity of oxygen sold [kg]</li> <li>• Emissions allocated to oxygen</li> </ul>

## Appendix P2 Hydrogen Production Pathway – Steam Methane Reforming (with Carbon Capture and Storage - CCS)

### P2.1. SMR/CCS Process Description

Currently, the steam methane reformer (SMR) is the leading technology for H<sub>2</sub> production from natural gas or light hydrocarbons. In an SMR facility, GHG emissions are produced via combustion of fossil fuels for heat and steam, and via the reforming reaction. Modern SMR based hydrogen production facilities have achieved efficiencies that could reduce CO<sub>2</sub> emissions down to nearly 10% above its theoretical minimum. Further reduction of CO<sub>2</sub> emissions from hydrogen production would only be possible by the integration of CCS.

The base case consists of: (a.) feedstock pre-treatment, (b.) pre-reformer, (c.) primary reformer, (d.) high temperature shift reactor and (e.) pressure swing absorption or PSA.

The current industry standard for capturing CO<sub>2</sub> from an SMR based H<sub>2</sub> plant is the capture of CO<sub>2</sub> from the shifted syngas using MDEA solvent. Four other CO<sub>2</sub> capture options are considered as the use of H<sub>2</sub> rich burner in conjunction with capture of CO<sub>2</sub> from shifted syngas using MDEA; the capture of CO<sub>2</sub> from PSA's tail gas using MDEA, or the use of Cryogenic and Membrane Separation; and the capture of CO<sub>2</sub> from flue gas using MEA. These options involve the CO<sub>2</sub> capture rate in the range of 56% to 90%.

The main simplified block flow diagram for a SME plant without CCS is described in **Figure P2. 1.**

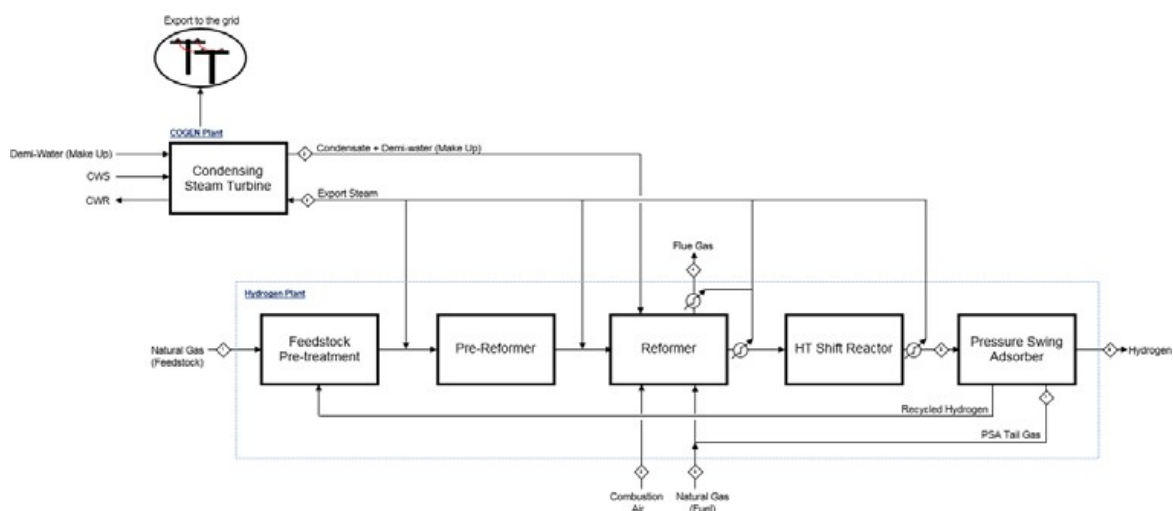

**Figure P2. 1: SMR plant without CO<sub>2</sub> capture<sup>30</sup>**

Different technology options are available in the market to capture CO<sub>2</sub> from the different gas streams of the H<sub>2</sub> plant.

<sup>30</sup> IEAGHG, "Techno-Economic Evaluation of SMR Based Standalone (Merchant) Plant with CCS", 2017/02, February, 2017





### P2.3. Emissions Sources In SMR/CCS

For steam methane reforming with CCS, the main source of GHG emissions is the conversion of natural gas (NG) to CO<sub>2</sub>. Other significant emissions sources include the scope 2 emissions of grid electricity, CO<sub>2</sub> removal, CO<sub>2</sub> compression for CCS.

Each process unit or stage in the SMR process contains unique emissions sources as outlined in **Table P2. 1**.

**Table P2. 1: Key life cycle GHG emission sources in H<sub>2</sub> production for SMR /CCS**

Process unit/stage	Key emissions sources	Other emissions sources
Natural gas recovery	<ul style="list-style-type: none"> <li>• Electricity and/or fuel combustion for natural gas extraction and transportation to a processing plant</li> <li>• Fugitive methane and/or carbon dioxide from natural gas extraction and transport</li> </ul>	<ul style="list-style-type: none"> <li>• Flaring and venting</li> </ul>
Natural gas processing	<ul style="list-style-type: none"> <li>• Electricity and/or fuel combustion for separating heavier components of recovered gas (e.g., natural gas liquid) or acid gases (e.g., CO<sub>2</sub>) from pipeline-quality natural gas</li> <li>• Fugitive methane and/or carbon dioxide from NG processing</li> </ul>	<ul style="list-style-type: none"> <li>• Flaring and venting</li> </ul>
NG transport	<ul style="list-style-type: none"> <li>• Electricity and/or fuel combustion for transportation</li> <li>• Fugitive Methane emissions</li> </ul>	
Heat recovery and electricity generation	<ul style="list-style-type: none"> <li>• No significant emissions other than those covered under common emissions sources</li> </ul>	
Auxiliary Heating Processes	<ul style="list-style-type: none"> <li>• Electricity and/or fuel combustion to provide auxiliary heat, e.g. in pre-heaters</li> </ul>	
Air separation	<ul style="list-style-type: none"> <li>• Electricity and/or fuel combustion to separate oxygen from air to feed reformer</li> </ul>	
CO <sub>2</sub> and H <sub>2</sub> purification	<ul style="list-style-type: none"> <li>• Electricity and/or heat for operation of the relevant purification units</li> </ul>	<ul style="list-style-type: none"> <li>• Exhaust CO<sub>2</sub> due to sulphur removal of exhaust gases (where applicable)</li> </ul>
Hydrogen enrichment	<ul style="list-style-type: none"> <li>• Electricity and/or heat to supply water gas shift reactions occurring as part of hydrogen enrichment (if relevant)</li> </ul>	
CO <sub>2</sub> capture and separation	<ul style="list-style-type: none"> <li>• Electricity and/or heat for relevant separation units</li> <li>• Residual CO<sub>2</sub> which is not captured for permanent storage</li> </ul>	

Compression and transportation of CO <sub>2</sub>	<ul style="list-style-type: none"> <li>• Electricity for compression of CO<sub>2</sub></li> <li>• Electricity and/or fuel combustion for pipeline transport</li> <li>• Liquid and/or fuel combustion for motive transport</li> <li>• Fugitive carbon dioxide emissions</li> </ul>	
Storage of CO <sub>2</sub>	<ul style="list-style-type: none"> <li>• Electricity/fuel for compression and injection</li> </ul>	<ul style="list-style-type: none"> <li>• Fugitive CO<sub>2</sub> from permanent storage location</li> </ul>
Hydrogen compression and storage	<ul style="list-style-type: none"> <li>• Electricity for compression and storage maintenance</li> </ul>	<ul style="list-style-type: none"> <li>• Fugitive hydrogen emissions<sup>31</sup></li> </ul>
Disposal of waste products (where not valorized)	<ul style="list-style-type: none"> <li>• Electricity and fuel combustion for transportation of waste products</li> </ul>	

## P2.4. Allocation for the SMR/CCS Pathway

Several co-products may exist for a SMR/CCS system. Steam, CO, electricity, and a captured CO<sub>2</sub> stream (but not considered here) are introduced as examples, but exact coproducts are representative of specific designs.

If steam is exported from the system, allocation by energy (cf. 6.3.3.4.2) is applied to calculate the associated GHG emissions.

If electricity is exported from the system, allocation by energy is applied to calculate the associated GHG emissions.

Allocation by energy is applied to calculate the energy use and CO<sub>2</sub>e emissions of the supply of by-product H<sub>2</sub> from a CO plant.

CO<sub>2</sub> capture and underground storage is considered as a CO<sub>2</sub> removal.

## P2.5. Information to Be Reported for H<sub>2</sub> production by SMR/CCS<sup>32</sup>

Category	Matters to be identified
Facility details	<ul style="list-style-type: none"> <li>• Facility identity</li> <li>• Facility location</li> <li>• Facility capacity (Nm<sup>3</sup>/h, t/h)</li> <li>• Capacity Factor (%)</li> <li>• Commencement of facility operation</li> </ul>

<sup>31</sup> The impacts of hydrogen as an indirect GHG have not been considered as part of this work given current focus on (direct) GHG emissions accounting.

<sup>32</sup> In a country where GO system and residual mix system are not used for electricity emission counting, reporting of GO and residual mix related matters cannot be necessary.

	<ul style="list-style-type: none"> <li>Main climatic and meteorological data (Atmospheric pressure, average ambient temperature, average relative humidity)</li> </ul>
Product specifications	<ul style="list-style-type: none"> <li>Production pathway</li> <li>H<sub>2</sub> produced (kg)</li> <li>H<sub>2</sub> temperature and pressure at the gate</li> <li>H<sub>2</sub> purity level at the gate</li> <li>Specification of contaminants</li> <li></li> </ul>
GHG emissions overview	<ul style="list-style-type: none"> <li>Emissions intensity of hydrogen batch [kgCO<sub>2</sub>e/kgH<sub>2</sub>]</li> <li>Type of offsets used (if applicable, noting that at this stage permitting the use of offsets is contentious and not recommended)</li> <li>Quantity of offsets used (if applicable, noting that at this stage permitting the use of offsets is contentious and not recommended)</li> </ul>
Batch details	<ul style="list-style-type: none"> <li>Beginning and end of batch dates</li> <li>Batch quantity [kg]</li> </ul>
Electricity	<p>Location based emissions accounting</p> <ul style="list-style-type: none"> <li>Quantity of purchased grid electricity [kWh]</li> <li>Location based emission factor used [kgCO<sub>2</sub>e/kWh]</li> <li>Quantity of sold electricity [kWh]</li> </ul> <p>Market based emissions accounting</p> <ul style="list-style-type: none"> <li>Quantity of purchased grid electricity [kWh]</li> <li>Quantity of contracted renewable electricity [kWh] and/or quantity of associated GOs or RECs</li> <li>Residual electricity [kWh]</li> <li>Residual mix emission factor [kgCO<sub>2</sub>e/kWh]</li> <li>Type of GOs or RECs</li> </ul> <p>On-site electricity generation</p> <ul style="list-style-type: none"> <li>Quantity of on-site generation [kWh]</li> <li>Emission factor for on-site generation (as applicable) [kgCO<sub>2</sub>e/kWh]</li> </ul>
Other utilities	<ul style="list-style-type: none"> <li>Source/s of water</li> <li>Source/s of steam</li> <li>Quantity of purchased water [kg]</li> <li>Quantity of purchased steam [kg]</li> <li>Embodied emission factor for water [kgCO<sub>2</sub>e/kg]</li> <li>Embodied emission factor for steam [kgCO<sub>2</sub>e/kg]</li> </ul>
Fuel feedstock	<ul style="list-style-type: none"> <li>Types of fuels combusted</li> <li>Quantities of fuel combusted [L, kg]</li> <li>Relevant emissions calculation or factors used [kgCO<sub>2</sub>e/relevant unit of fuel]</li> <li>Emissions intensity of fuel used, including all emissions associated with fuel extraction, transporting to a processing plant, and processing [e.g. kgCO<sub>2</sub>e/mmbtu]</li> <li>Credits claimed to evaluate emissions of fuel reformed</li> </ul>
Process	<ul style="list-style-type: none"> <li>SMR reactor type</li> <li>Air separation technology and capacity</li> <li>Syngas purification technology and capacity</li> <li>Sulphur waste gas processing technology (if applicable)</li> </ul>

	<ul style="list-style-type: none"> <li>• Quantity and type of vented GHG gases [kg]</li> <li>• Quantity and type of flared GHG gases [kg]</li> <li>• Technology for monitoring fugitives from CO<sub>2</sub> storage and capacity</li> <li>• CO<sub>2</sub> capture rate of the unit [%]</li> </ul>
Air separation	<ul style="list-style-type: none"> <li>• Electricity/fuel consumption</li> </ul>
Cooling	<ul style="list-style-type: none"> <li>• Electricity consumption [MWh]</li> </ul>
Compression of gases throughout the facility	<ul style="list-style-type: none"> <li>• Electricity consumption [MWh]</li> </ul>
Natural gas feedstock	<ul style="list-style-type: none"> <li>• Type of NG</li> <li>• NG composition</li> <li>• Quantity of NG used for SMR reactions [kg]</li> <li>• Quantity of NG used for heating [kg]</li> <li>• Quantity of NG used for producing steam [kg]</li> <li>• Embodied emission factor for NG [kgCO<sub>2</sub>e/kg] (derived from primary and secondary data, provided by supplier or sourced from relevant source i.e. NGA Factors)<sup>33</sup></li> </ul>
Carbon dioxide treatment	<ul style="list-style-type: none"> <li>• Type of CO<sub>2</sub> storage and capacity</li> <li>• Location of CO<sub>2</sub> storage</li> <li>• Transport type of CO<sub>2</sub> to storage location (if applicable) and distance (in km)</li> <li>• Quantity of CO<sub>2</sub> captured [kg]</li> <li>• Quantity of CO<sub>2</sub> stored [kg]</li> <li>• Quantity of fugitive emissions created during injection of CO<sub>2</sub> into the storage location [kg]</li> <li>• Quantity of fugitive CO<sub>2</sub> emissions from storage [kg] (in line with period covered by the reporting)</li> </ul>
Waste and other Co-products	<ul style="list-style-type: none"> <li>• Quantity of steam produced [kg]</li> <li>• Quantity of steam sold [kg]</li> <li>• Emissions allocated to steam [kgCO<sub>2</sub>e/kg]</li> <li>• Quantity of electricity sold (MWh)</li> <li>• Emissions allocated to electricity sold [kgCO<sub>2</sub>e/kWh]</li> </ul>

<sup>33</sup> Note that where upstream emissions are derived using upstream data, there may be a requirement for additional information. This could include items such as coal source.

## Appendix P3 Hydrogen Production Pathway – Industrial By-Product

### P3.1. By-Product Process Description

#### Chloralkali industry

There are 3 main processes: mercury cell, diaphragm cell and membrane cell. Membrane cell process is the most recently developed process (1970s) and is the most economic and environmentally-friendly process [Hung, et al., 2017]. The membrane process is used in 83.3% of chlor-alkali plants in the EU [Eurochlor, 2020] and is the only process still operational in the Netherlands [Scherpbier and Eerens, 2020]. As of 2019 there are no mercury plants operational anymore in the EU [Eurochlor, 2020]. The remaining plants are diaphragm (11.6%) and others (5.1%) (including chlorine and caustic soda production without hydrogen as a by-product) [Eurochlor, 2020]

In the EU, 9.4 Mton chlorine was produced in 2019 [Eurochlor, 2020]. With 28.4 kton H<sub>2</sub> produced per Mton chlorine with the membrane process [Scherpbier and Eerens, 2020] this corresponds to around 250 kton H<sub>2</sub> produced as a by-product in 2019 from membrane and diaphragm plants.

Worldwide there are at least 400 chloralkali plants, with a production capacity of 75 Mton chlorine per year [World Chlorine Council, 2017]. This corresponds to up to 2.1 Mton H<sub>2</sub> production per year (assuming all plants use membrane technology)

Hydrogen can either be sold (merchant hydrogen) for industrial non-energy applications or used as fuel [Hung, et al., 2017]. Since 2002, 85-90% of the produced hydrogen in the EU is used [Eurochlor, 2020].

#### Process description by-product hydrogen production from the Chloralkali process

- The chloralkali process is an industrial process for the electrolysis of sodium chloride (NaCl) solutions. It is the technology used to produce chlorine (Cl<sub>2</sub>) and sodium hydroxide (NaOH, caustic soda) which are commodity chemicals required by industry. Next to these main products for every mole of chlorine produced, one mole of by-product hydrogen is produced. Currently, much of this hydrogen is used to produce hydrochloric acid, ammonia, hydrogen peroxide, or is burned for power and/or steam production.
- Saturated (NaCl solution) brine enters the electrolysis cell at the anode side where the chloride ions are oxidized at the anode, losing electrons to become chlorine gas:  
$$2\text{Cl}^- \rightarrow \text{Cl}_2 + 2\text{e}^-$$
- At the cathode, positive hydrogen ions pulled from water molecules are reduced by the electrons provided by the electrolytic current, to hydrogen gas, releasing hydroxide ions into the solution:  
$$2\text{H}_2\text{O} + 2\text{e}^- \rightarrow \text{H}_2 + 2\text{OH}^-$$
- The ion-permeable membrane/diaphragm at the center of the electrolysis cell allows the sodium ions (Na<sup>+</sup>) to pass to the cathode side where they react with the hydroxide ions to produce caustic soda (NaOH). The overall reaction is:

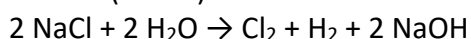

Technology improvements can have an impact on the amount of hydrogen produced and the energy required for electrolysis, thereby having an impact on the emission factor for hydrogen

Zero-gap membranes decrease the distance between the anode and the cathode, reducing electrical resistance and heat production. Energy savings using zero-gap technology are ~10% [Scherpbier and Eerens, 2020]. This technology has become widespread since 2010, but due to high investment costs not all plants have converted yet.

Instead of producing hydrogen at the cathode, an oxygen depleted cathode (ODC<sup>34,35,36,37</sup>) can be used – replacing the production of hydrogen by the use of oxygen. ODC reduces the required electricity for electrolysis by 30-40%, but the savings do not weigh up to the reduced income from hydrogen sales [Scherpbier and Eerens, 2020].

In formula form:

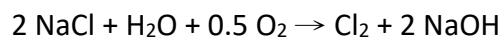

### Steam cracking

Naphtha is the dominant feedstock for steam crackers, although steam cracking of ethane has become more attractive due to developments in shale gas extraction [Amghizar, et al., 2017]

With ethane as feedstock, hydrogen share in products is higher: 4% by mass [Lee and Elgowainy, 2018]

Annual production of ethylene is roughly 150 Mton (80 Mton propylene), naphtha steam cracking representing roughly 10% of this [Amghizar, et al., 2017]

Which roughly translates to 350-450 kton hydrogen production from naphtha steam cracking

In the US total potential hydrogen production from steam cracking is estimated to be 3.5 Mton hydrogen per year – 55% from existing plants and 45% from planned plants [Lee and Elgowainy, 2018]

Hydrogen produced in steam crackers is typically used as combustion fuel for the cracker, mixed with methane that is also produced as by-product or is imported from the grid [Lee and Elgowainy, 2018]

---

<sup>34</sup> Chavan & Turek (2015); Chavan, N., Turek, T., Non-isothermal model for an industrial chlor-alkali oxygen depolarized cathode, *Journal of Applied Electrochemistry* (2015)

<sup>35</sup> Moussallem, I., Jorissen, J., Kunz, U., Pinnow, S., Turek, T. (2008); Chlor-alkali electrolysis with oxygen depolarized cathodes: history, present status and future prospects, *J Appl Electrochem* (2008) 38: 1177-1194

<sup>36</sup> S. Bechtela, T. Vidakovic-Kocha, K. Sundmachera, Novel process for the exergetically efficient recycling of chlorine by gas phase electrolysis of hydrogen chloride, *Chemical Engineering Journal* 346 (2018) 535–548

<sup>37</sup> J. Jung, S. Postels, A. Bardow, Cleaner chlorine production using oxygen depolarized cathodes? A life cycle assessment, *Journal of Cleaner Production* 80 (2014) 46-56

Process description by-product hydrogen production from (naphtha) Steam Cracking:

- Steam cracking of naphtha is used to generate olefins, e.g. for the production of plastics. First, naphtha is pre-heated to a temperature of 550-600°C while steam at a temperature of 180-200°C is added. Then, the naphtha is heated up to a temperature of 800-850°C where the hydrocarbon chains are cracked into ethylene and propylene as main products as well as various other compounds as by-products, thereof about 1% hydrogen by mass, or 2.63% by energy.
- The following table shows the yield of products and its composition for a typical steam cracking plant [CertifHy 2015].

**Table P3. 1: Yield and Product Composition of a Typical Steam Cracking Plant**

Product	Share (%-energy)	Energy stream (TJ/yr)
H <sub>2</sub>	2.63%	358
CO	0.01%	1
CH <sub>4</sub>	16.34%	2,226
C <sub>2</sub> H <sub>2</sub>	0.70%	96
C <sub>2</sub> H <sub>4</sub>	31.14%	4,242
C <sub>2</sub> H <sub>6</sub>	3.46%	471
C <sub>3</sub> H <sub>6</sub>	15.80%	2,152
C <sub>3</sub> H <sub>8</sub>	0.37%	51
C <sub>4</sub> H <sub>8</sub>	9.15%	1,246
Pyrolysis gasoline	17.69%	2,410
Pyrolysis fuel oil	2.69%	367
<b>Total</b>	<b>100.00%</b>	<b>13,622</b>

### P3.2. By-Product Overview

The flow diagram of the chloralkali process is presented in **Figure P3. 1**.

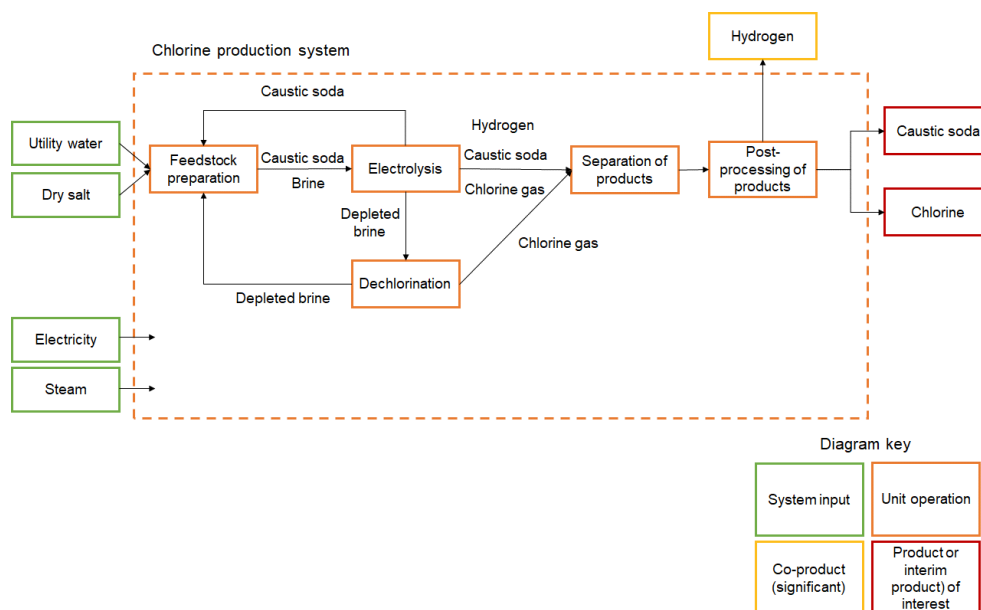

**Figure P3. 1: Process diagram for hydrogen produced from chloralkali process**

The flow diagram of steam cracking is presented in **Figure P3. 2**.



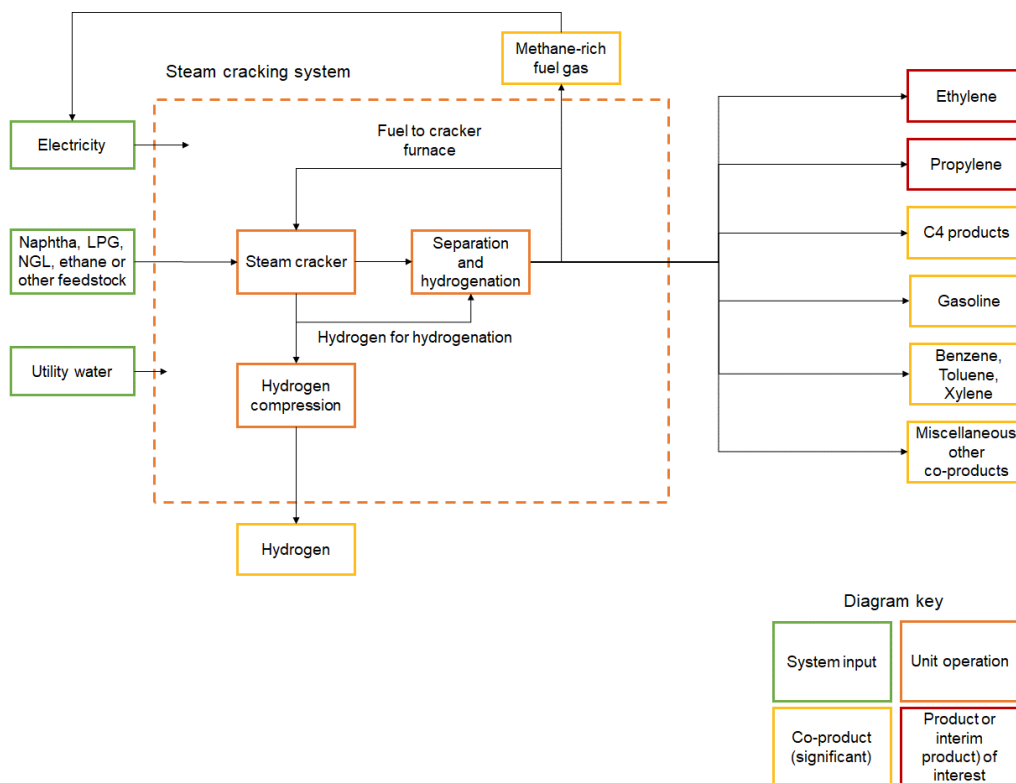

**Figure P3. 2: Process diagram for hydrogen produced from steam cracking**

Of importance is how the hydrogen is used. In this example  $\sim 2/3$  of hydrogen is used as part of the fuel gas for the furnace (U02) and  $1/3$  is part of fuel gas used to fire a boiler (U01). [Spallina, et al., 2017].

### P3.3. Emissions Sources in By-Product

#### Chloralkali industry

The main emissions from the chloralkali production process are energy-related emissions. To produce a million tonnes of chlorine approximately 10 PJ of energy input is required, 1.9 PJ heat and 8.2 PJ electricity (see **Figure P3. 3**).

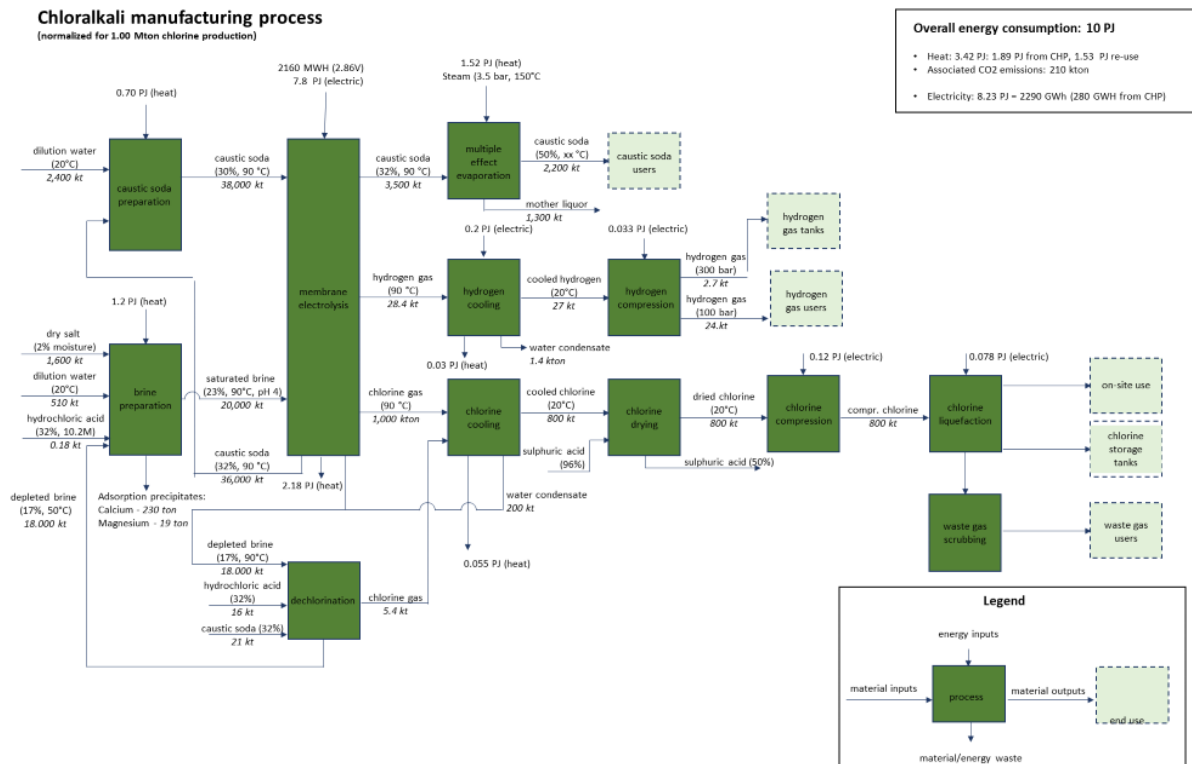

**Figure P3. 3: Energy diagram for the chloralkali process [Scherpbier and Eerens, 2020]**

Other indirect emissions from the chloralkali process include emissions from salt (NaCl) mining and purification. 175 kg of NaCl is required as input per gigajoule hydrogen produced [CertifHy 2015].

### Steam cracking

Emissions from steam cracking are related to the combustion of fuel gas used to provide the required heat to the process. Combustion occurs at the furnace and boilers (see for example **Figure P3. 2**). The emissions depend on the feedstock used in the steam cracking process (naphtha, ethane, propane, butane, or gasoil).

### P3.4. Allocation for The By-Product Pathway

#### Chloralkali industry

Six allocation methods were explored for hydrogen production as a by-product in the chloralkali sector. The results are presented in **Table P3. 2**

Enthalpy-based allocation was explored by the CertifHy project, resulting in an allocation factor for hydrogen of 52.9% [CertifHy, 2015].

**Table P3. 2: Electricity consumption for the production of hydrogen from chloralkali electrolysis.**

	Unit	Allocation by energy
<b>Before allocation</b>	kWh/kg <sub>H2</sub>	80.75
	kWh/kWh <sub>H2, LHV</sub>	2.4233
<b>Allocation factor</b>		52.9%
<b>After allocation</b>	kWh <sub>e</sub> /kWh <sub>H2, LHV</sub>	1.2822

Mass-based allocation is based on mass balances from Scherpbier and Eerens (2020). For every Mton chlorine, 1.1 Mton caustic soda and 28.4 kton hydrogen are produced (see **Figure P3. 3**, where caustic soda is 50% diluted). Leading to a hydrogen share in the mass balance of ~1.3% (Lee and Elgowainy 2018).

Market value-based allocation was also explored by the CertifHy project, where an allocation factor of 11% was found [CertifHy, 2015]. Scherpbier and Eerens (2020) find a lower factor of 9% for the Netherlands. In Japan the market-value based allocation method leads to an allocation factor of 13%.

The CertifHy project also explored an allocation method based on the energy savings provided by the ODC process, where hydrogen is not produced as a co-product. The emissions of the co-produced hydrogen are the indirect emissions of the electricity that would be saved if the ODC process was implemented. It was assumed that energy savings amount to 25%, based on supplier information. This is corrected for the electricity required to produce oxygen (4.1%), resulting in an allocation factor of 20.9%.

For the substitution method, it is assumed that every MJ hydrogen used for heat in the chloralkali process is replaced by 1 MJ natural gas. The Dutch natural gas emissions intensity of 56.8 gCO<sub>2e</sub>/MJ is used.

Molar-based allocation is based on the molar fraction of hydrogen produced in the process (25%, with another 25% for chlorine and 50% for NaOH).

The hydrogen emissions intensity in **Table P3. 3** are largely based on CertifHy (2015), where the intensity was determined based on the CO<sub>2</sub> intensity of the Dutch residual electricity mix and electricity from natural gas. Here we only use the CO<sub>2</sub> intensity of the residual mix in 2017 (642 gCO<sub>2e</sub>/kWh). With approximately 100 kWh required for 1 kg hydrogen. Scherpbier and Eerens (2020) base the emissions intensity on the total emissions from the chloralkali sector in the Netherlands. For the substitution method the natural gas emissions intensity in the Netherlands is used.

**Table P3. 3: Results of various emission allocation methods for hydrogen as by-product from the chloralkali industry.**

Allocation Method	Share of emissions to be allocated to hydrogen	Hydrogen emissions intensity (gCO <sub>2e</sub> /MJ LHV H <sub>2</sub> )	Sources

Enthalpy-Based	53%	282	CertifHy (2015)
Mass-Based	1.3%	11.7	Lee and Elgowainy (2018)
Market Value-Based	9-11%	34-59	Scherpbier and Eerens (2020) and CertifHy (2015)
Based on the energy savings provided by the ODC process	21%	134	CertifHy (2015) Jung.(2014) and Bechtel (2018)
Substitution	-	57	Own calculation
Molar-Based	25%	134	Own calculation

As energy-based allocation used in the other investigated pathways is not feasible, it is recommended for this first version to use the system expansion allocation based on the ODC process.

### Steam cracking

Three allocation methods were explored for steam cracking. The findings are summarised in **Table P3. 6**.

Energy-based allocation is based on findings from CertifHy (2015), with a hydrogen energy-share of 2.63%.

Lee and Elgowainy (2018) explored a substitution method, a mass-based allocation method and a market value-based allocation method. For the substitution method the share of hydrogen in the fuel gas depends on the feedstock used. Also dependent on the feedstock, natural gas to substitute hydrogen in fuel gas is either obtained from external sources or from the excesses in the tail gas. In the latter case, the amount of methane exported decreases. In all substitution cases, replacing hydrogen in fuel gas with methane increases the plant emissions. The authors estimate a WTG emission factor of 8.5-10 kgCO<sub>2</sub>e/kgH<sub>2</sub>, equivalent to 78 – 83 gCO<sub>2</sub>e/MJ hydrogen.

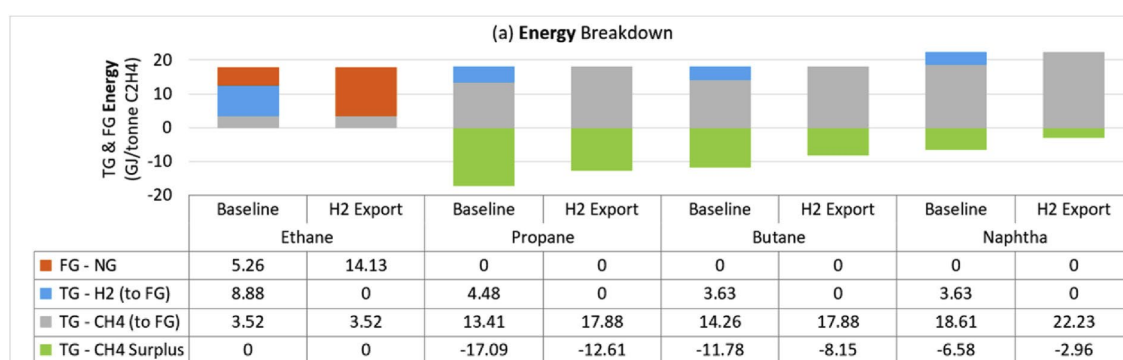
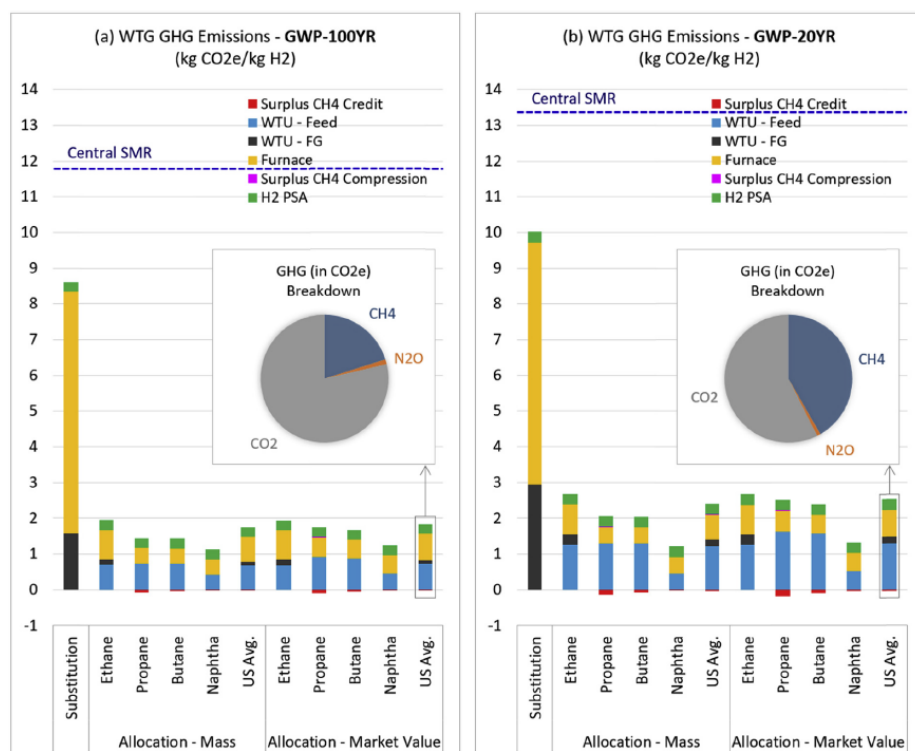

Fig. 3 – Breakdown of fuel gas (FG), a mixture of tail gas (TG, from steam crackers) and natural gas (NG, from the grid), flowing into a furnace as well as surplus methane (CH<sub>4</sub>) in TG for two scenarios: baseline (hydrogen in TG is combusted in furnace) vs. H<sub>2</sub> export (hydrogen is exported to external market). Per 1 tonne of ethylene (C<sub>2</sub>H<sub>4</sub>) produced, energy intensity is the lowest (17.6 GJ/tonne C<sub>2</sub>H<sub>4</sub>) for ethane feedstock and highest (22.2 GJ/tonne C<sub>2</sub>H<sub>4</sub>) for naphtha. All in lower heating value (LHV).

**Figure P3.4: Breakdown of fuel gas (FG)**

Using mass or market value allocation methods also depend on feedstock used, as this determines the share of co-products from the steam cracker. The figure below shows the estimated emission factors are lowest for naphtha steam crackers (just over 1 kgCO<sub>2</sub>e/kg H<sub>2</sub> or 8 gCO<sub>2</sub>e/MJ H<sub>2</sub>) and highest for ethane steam crackers (2-3 kgCO<sub>2</sub>e/kg H<sub>2</sub> or 17-25 gCO<sub>2</sub>e/kg H<sub>2</sub>).



**Figure P3.5: Life-cycle (well-to-gate) greenhouse gas emissions**

Wong and van Dril (2020) also assimilated data on the mass balance from steam cracking, based on the feedstock used. The hydrogen mass fraction is 0.5-2%, which is of a similar order of magnitude as the findings from Lee and Elgowainy (2018).

**Table P3. 4: Typical yield of co-products from feedstock's for steam cracking process (acc, 2004).**

Product (kt)	Feedstock		
	Propane (LPG)	Naphtha	Gasoil
Ethylene	453.6	453.6	453.6
Propylene	166 - 296.5	199 - 222	183 - 196
Butadiene	18 - 32	56 - 77	76 - 82
Butenes/Butanes	13 - 22	60 - 128	78 - 88.5
Pyrolysis gasoline	47 - 71	183 - 494	294 - 342.5
Benzene	17 - 26.5	51 - 84	96 - 109
Toluene	5 - 5.5	19.5 - 71.5	51 - 54.4
C <sub>8</sub> aromatics	0	26.5 - 43	20 - 43
Other	25 - 39	86 - 295	127 - 136
Fuel oil	4.5 - 10	29.5 - 51	289 - 376.5
Methane-rich gas	263 - 296.5	199 - 222	183 - 196
Hydrogen-rich gas	17 - 21	11 - 14	12 - 26.5
Total	982 - 1,200	1,173 - 1,670	1,614 - 1,822
Ethylene yield (%)	38 - 46	27 - 39	25 - 28

A market value-based allocation factor was also calculated based on the co-product mass balance from Wong and van Dril (2020) and European prices as given in Boulamanti and Moya (2017). Market values can differ significantly over time and across the world and the share allocation can be influenced by this.

**Table P3. 5: Market value-based allocation for hydrogen co-product from steam cracking based on Wong and van Dril (2020) and European co-product from Boulamanti and Moya (2017).**

Product	Value (€/ton)	Propane (M€)	Naphta (M€)	Gasoil (M€)
Ethylene	748	339	339	339
Propylene	1008	117-299	201-224	184-197
Butadiene	885	16-28	50-68	67-73
Butenes/butanes	639	8-14	38-82	50-57
Pyrolysis gasoline	789	74-112	289-779	464-540
Fuel oil	468	2-5	14-24	135-176
Methane-rich gas	526	138-156	105-117	69-103
Hydrogen-rich gas	1344	23-28	15-19	16-36
<b>Total</b>	-	<b>718-981</b>	<b>1050-1651</b>	<b>1352-1521</b>
<b>Hydrogen share</b>	-	<b>3%</b>	<b>1%</b>	<b>1-2%</b>

**Table P3. 6: Results of various emission allocation methods for by-product hydrogen from steam cracking.**

Allocation method	Share of emissions to be allocated to hydrogen	Hydrogen emissions intensity (g CO <sub>2e</sub> /MJ LHV H <sub>2</sub> )	Sources
Energy-based	2.6%	21.8	CertifHy (2015)
Substitution	-	71 - 83	Lee and Elgowainy (2018)
Mass-based	0.5 - 4%	8 - 25	Wong and van Dril (2020), Lee and Elgowainy (2018)
Market value-based	1 - 3%	8 - 25	Wong and van Dril (2020), Boulamanti and Moya (2017), Lee and Elgowainy (2018)

As subdivision of system is recommended for by-product hydrogen from steam cracking when feasible (6.3.3.4.2).

## Appendix P4 Hydrogen Production Pathway – Coal Gasification (With Carbon Capture and Storage - CCS)

### P4.1. Coal Gasification/CCS Process Description

Coal is removed from coal seams using either open-pit or underground mining depending upon the depth of the coal seam. These operations consume electricity for conveying to and from storage areas and through the crushing and washing facilities.

The coal is transported to a processing facility via ships, trucks and trains. Loading and unloading steps typically employ electricity driven stackers/reclaimers and associated conveyors. Transport vessels use diesel, fuel oil or electricity for motive power.

To produce hydrogen gas, coal is mixed with oxygen and steam in a reactor (a gasifier). The basic gasification reaction is:

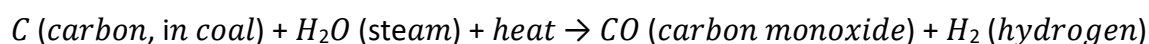

The reaction takes place at high temperatures and some of the coal is oxidised by the oxygen to produce the energy needed to drive the reaction:

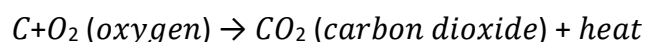

The oxygen used in the gasifier is generated in an air separation unit. Oxygen is used in preference to air, to prevent nitrogen diluting and contaminating the hydrogen. Air separation technologies include cryogenic distillation, pressure-swing adsorption, and membrane separation. All consume large quantities of electricity. In addition to liquid oxygen and liquid nitrogen, crude liquid argon may also be produced in smaller quantities (argon constitutes about 0.93% of air) (Althaus, 2007). Pending the scale and valorisation of these outputs, they may be considered as co-products and allocated emissions.

A gasifier is a high temperature reactor where coal undergoes partial oxidation and reaction with steam. There are three main types of gasifiers that can be used to create syngas, each varying in the method it uses to generate heat, to contact the reactants and the physical state of the residue it produces. These are fixed bed (e.g. Sasol-Lurgi gasifiers), fluidised bed (e.g. Winkler gasifiers) and entrained flow (e.g. Koppers-Totzek gasifiers) (Kopp, 2000) (Higman, 2008). These different gasifiers have their advantages and disadvantages but at a macro level perform the same function. They have common inputs (coal, oxygen and water) but can produce syngas with varied properties, also subject to the properties of the coal, which will impact the configuration of downstream processing activities.

This unit also produces ash and/or slag as waste products.

Waste heat recovery units are typical for coal gasification processes, reflecting the high temperature operation of coal gasification processes and the requirement for cooling of

syngas products for subsequent processing. Regulation of the gasifier temperature is managed through a heat exchanger which can be used to raise steam and generate electricity. Steam may be supplied elsewhere in the plant (i.e. steam use in regeneration of acid gas removal (AGR) absorption systems) or exported out of the product system boundary. Electricity may be generated from this steam and used elsewhere in the plant such as to drive the air separation process, or exported beyond the product system boundary.

Any exported steam and/or electricity is considered a co-product and should be allocated a share of emissions.

### **Syngas conditioning**

The output of the gasifier is a stream of raw syngas, which may contain a number of contaminants, including particulate matter and heavy metals. In addition, this stream contains significant CO gas. To maximise the quantity of hydrogen produced, syngas from the gasifier is sent through to another reactor where the carbon monoxide is reacted with water to yield additional hydrogen. This is known as the water-gas shift (WGS) reaction, as follows:  $CO+H_2O \rightarrow CO_2+ H_2+heat$ . This is a reversible reaction, with an equilibrium established between CO and CO<sub>2</sub>, subject to the reaction conditions. Low temperatures favour the formation of CO<sub>2</sub>. As the conversion of CO to CO<sub>2</sub> generates heat, there are often several water gas shift reactors in series with coolers between them (including high temperature and low temperature stages). Typically, iron-chromium and copper-zinc catalysts are used to facilitate the reaction at high and low temperatures, respectively (Pal, Chand, Upadhyay, & Mishra, 2018). High temperature WGS may include conversion of sulphur compounds to hydrogen sulphide (H<sub>2</sub>S), for removal in the acid gas removal (AGR) stage.

The syngas now includes large quantities of CO<sub>2</sub> in addition to other impurities including sulphur compounds (such as H<sub>2</sub>S) and heavy metals (such as mercury). These components must be removed from the syngas. Particulate matter can be removed using a water scrubber. Mercury and other heavy metals can be removed by via adsorption, particularly using activated carbon beds. Drying (water removal) is also required (Higman, 2008). Sulphur compounds may be removed using lime. CO<sub>2</sub> and sulphur compounds can also be removed together. The capture of CO<sub>2</sub> and removal of these sulphur compounds simultaneously is discussed below.

Whilst configurations for syngas conditioning vary, the key inputs and outputs (electricity, heat) are largely common.

### **Carbon capture and storage (CCS)**

Carbon capture, and storage (CCS) refers to the capture and storage of waste carbon dioxide in a geologic reservoir, for the purposes of reducing emissions of CO<sub>2</sub> to the atmosphere. The CCS stage consists of three main unit operations including separation and capture, compression and transport and storage or utilisation.

### **CO<sub>2</sub> capture and separation**

Acid gas removal refers to the separation of H<sub>2</sub>S and CO<sub>2</sub> (for carbon capture) via physical solvents (such as the Selexol™ system), chemical solvents (such as mono-ethanol amine



(MEA)), other means (such as pressure swing adsorption (PSA)) or some combination which reflects syngas properties and product output requirements. Removal of H<sub>2</sub>S and CO<sub>2</sub> at a large scale is typically performed by passing the syngas through a counter-current absorption column with a regenerative solvent (physical or chemical). For pre-combustion carbon capture processes physical absorption is favoured given typically high CO<sub>2</sub> partial pressures (Vega, et al., 2018). To pump the solvent through the absorber and recover the solvent, heat exchangers, reboilers, coolers and pumps are required. Sulphur containing gas (particularly H<sub>2</sub>S) from the regeneration unit is produced which may be processed into sulphur in a Claus plant (Chiche, Diverchy, Lucquin, Porcheron, & Defoort, 2013). This sulphur may be sold as a co-product. However, given the scale of this sulphur source and the requirement for additional processing, the H<sub>2</sub>S stream is considered a waste stream. Although solvent absorption is the most common method of syngas purification, if the gas contains significant concentrations of other gases besides H<sub>2</sub> and CO<sub>2</sub>, other methods may be preferred (Hofbauer, Rauch, & Ripfel-Nitsche, 2007). The two main alternative processes are pressure-swing adsorption (PSA) and cryogenic distillation. However, membrane separation has also gained a lot of attention in the last decade (Rezaee & Naeij, 2020), and several types of membranes are now available which can be used to produce hydrogen streams of very high purity (Scholes, Smith, Kentish, & Stevens, 2010). For the purpose of this work and at a macro level, the many capture processes and the corresponding complex unit operations can each be simply treated as units that separate hydrogen from carbon dioxide through the application of electricity and heat (typically low-grade).

### **CO<sub>2</sub> compression and transportation**

Prior to transportation, the purified CO<sub>2</sub> gas must be pressurised. Selection and design of compressors should be reflective of both the condition and scale of the carbon capture and transport required (Martynov, Daud, Mahgerefteh, Brown, & Porter, 2016). Key inputs will be electricity to power compression, with petroleum oils and greases required for operation. This transport can occur in multiple ways including pipeline, road tankers, rail tankers and ships (National Research Council, 2007). For large volumes of CO<sub>2</sub>, pipelines are generally the most economical form of transportation. Where pipelines are used, leakage rates must be considered across the length of the pipeline, subject to operating pressure.

### **Storage of CO<sub>2</sub>**

There are several ways the CO<sub>2</sub> can be stored permanently. In this case, the amount of CO<sub>2</sub> stored is considered as a removal (considering the associated emissions due to its separation, capture, compression, transport and storage).

There are currently two broad categories: the storage of gaseous CO<sub>2</sub> in geological formations and the reaction of CO<sub>2</sub> to form stable minerals. There is also some interest in the use of biological matter (bacteria and algae) which degrade captured CO<sub>2</sub> over time. Geological storage typically involves the injection of supercritical CO<sub>2</sub> into deep underground geological formations such as oil and gas fields, unmineable coal seams and saline formations (Environmental and Energy Study Institute, 2020). CO<sub>2</sub> may also be dissolved in aquifer water, with saline aquifers of particular interest (given frequency and potential storage volume) (Environmental and Energy Study Institute, 2020). Mineral sequestration refers to the reaction of CO<sub>2</sub> to form stable minerals, particularly carbonates. The Hydrogen Energy Supply

Chain project in the Latrobe Valley is planning to establish a CCS network from the hydrogen production facility to offshore storage locations within the Gippsland Basin (HESC, 2020). There are a number of ancillary activities including modelling, drilling of monitoring wells, monitoring of the CO<sub>2</sub> plume throughout injection and long-term monitoring of sequestration sites for potential leakage (this may include subsurface monitoring, seismic monitoring, surface monitoring). Geological storage is of greater concern as mineral storage is not considered to have significant leakage risks.

### **Hydrogen compression and buffer storage**

Common to hydrogen produced via coal gasification, electrolysis, and any other means is the requirement for compression of the dry, high purity hydrogen product. This is particularly important given the low density of hydrogen gas. Subject to the nature of downstream hydrogen storage, transport and use, there will be different requirements for hydrogen compression. Common to the coal gasification, electrolysis and steam methane reforming pathways, there are four main approaches to hydrogen storage: compressed gaseous hydrogen, liquid hydrogen and materials-based storage technologies (either physical or chemical).

With regards to hydrogen compression and storage, it is important to be clear about the boundary for certification. Where storage is required for the delivery of the functional unit (i.e. hydrogen under the specific boundary conditions) this must be included within the system boundary. However, where the hydrogen is processed (for storage or otherwise) in such a way as to provide additional functionality (e.g. the liquefaction of hydrogen for delivery to customer to meet their preferences) this should be treated using a module (or annex, yet to be developed) covering hydrogen energy carriers. Different forms of storage are briefly described below but their inclusion within the defined system boundary is subject to the considerations noted above.

Compression refers to the storage of hydrogen in its gaseous form at higher pressures. This includes pressurisation of hydrogen within steel cylinders but also includes large-scale and longer-term storage in locations such as salt caverns and depleted gas fields, and the storage of hydrogen in existing natural gas pipelines (line packing) (Makridis, 2016).

## P4.2. Coal Gasification /CCS Overview

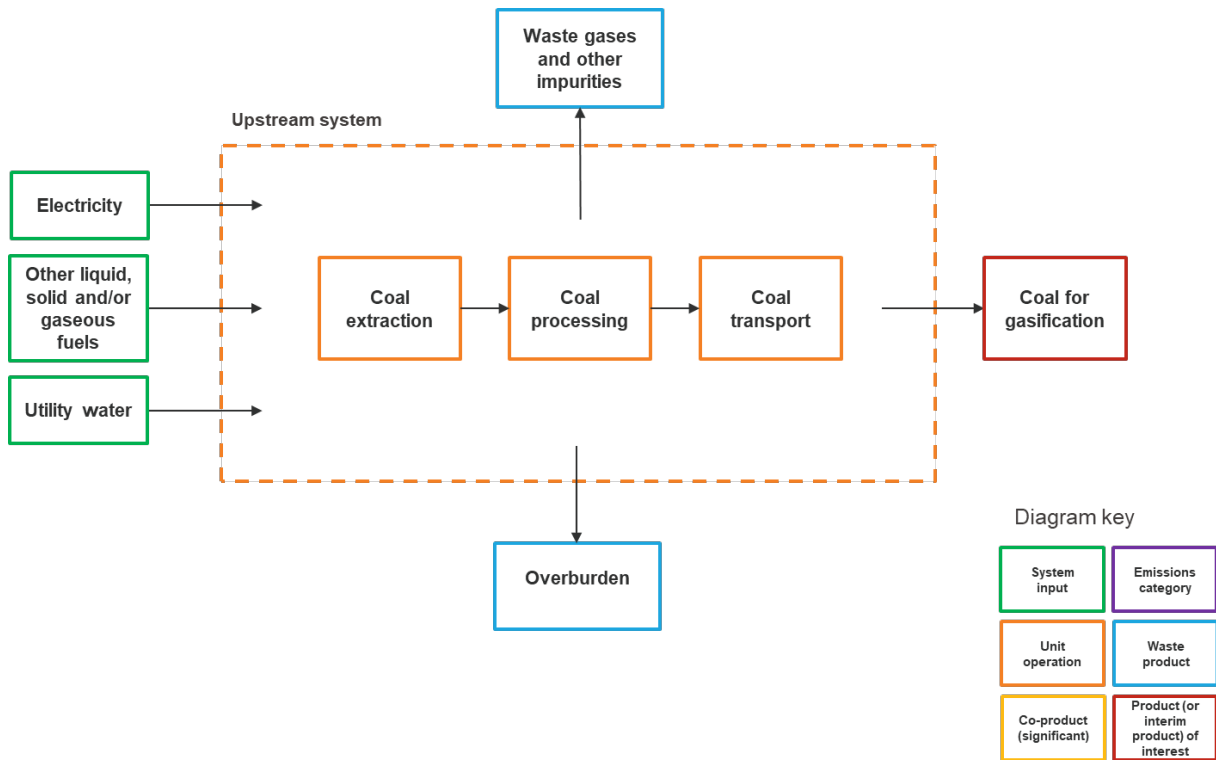

Figure P4. 1: Coal gasification upstream system

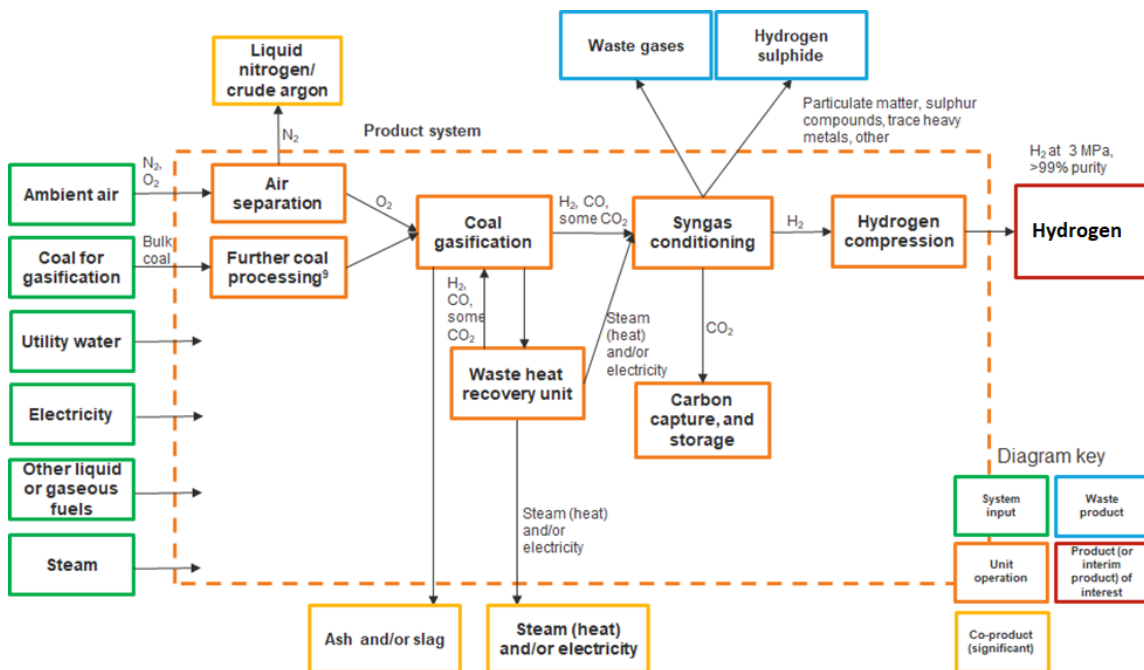

Figure P4. 2: Coal Gasification system

### P4.3. Emissions Sources In Coal Gasification /CCS

For coal gasification with CCS, the main source of GHG emissions is the conversion of carbon in coal to CO<sub>2</sub>. Other significant emissions sources include the scope 2 emissions of grid electricity used for air separation (including air compression and oxygen compression), CO<sub>2</sub> removal, CO<sub>2</sub> compression for CCS, coal processing (size reduction and cleaning) activities and fugitive methane emissions associated with coal mining.

Each process unit or stage in the coal gasification process contains unique emissions sources as outlined in **Table P4. 1**.

**Table P4. 1: GHG emissions summary for coal gasification /CCS**

Process unit/stage	Key emissions sources	Other emissions sources
Coal mining and processing	<ul style="list-style-type: none"> <li>Electricity and/or liquid fuel combustion for materials extraction and movement</li> <li>Fugitive methane and/or carbon dioxide from coal extraction</li> </ul>	Explosives for coal extraction
Primary coal processing	<ul style="list-style-type: none"> <li>Electricity for loading and unloading of coal</li> <li>Electricity for coal size reduction, washing and separation</li> </ul>	Chemical usage for coal processing
Coal transport	<ul style="list-style-type: none"> <li>Electricity and/or liquid fuel combustion for materials movement</li> </ul>	
Further coal processing	<ul style="list-style-type: none"> <li>Electricity for additional size reduction</li> </ul>	Electricity and/or liquid fuel combustion for materials movement
Air separation	<ul style="list-style-type: none"> <li>Electricity for air compression</li> </ul>	
Gasification	<ul style="list-style-type: none"> <li>Combustion of coal within the gasifier</li> <li>Gasification of coal within the gasifier</li> <li>Steam for gasification (if purchased from third party rather than self-generated)</li> </ul>	
Heat recovery and electricity generation	<ul style="list-style-type: none"> <li>No significant emissions other than those covered under common emissions sources</li> </ul>	
Hydrogen enrichment	<ul style="list-style-type: none"> <li>Water gas shift reactions occurring as part of hydrogen enrichment</li> </ul>	
Syngas purification	<ul style="list-style-type: none"> <li>Electricity and/or heat for operation of the relevant purification units</li> </ul>	Exhaust carbon dioxide due to sulphur removal of exhaust gases using lime (where applicable)
CO <sub>2</sub> capture and separation	<ul style="list-style-type: none"> <li>Electricity and/or heat for relevant separation units</li> </ul>	

Compression and transportation of CO <sub>2</sub>	<ul style="list-style-type: none"> <li>• Electricity for compression of CO<sub>2</sub></li> <li>• Electricity and/or gaseous fuel combustion for pipeline transport</li> <li>• Liquid and/or gaseous fuel combustion for motive transport</li> <li>• Fugitive carbon dioxide from CO<sub>2</sub> transportation</li> </ul>	
Storage of CO <sub>2</sub>	<ul style="list-style-type: none"> <li>• Electricity for injection or transformation</li> </ul>	Fugitive carbon dioxide from permanent storage location
Hydrogen compression and storage (if in the production boundary)	<ul style="list-style-type: none"> <li>• Electricity for compression and storage maintenance</li> </ul>	Fugitive hydrogen emissions <sup>38</sup>

#### P4.4. Allocation for The Coal Gasification /CCS Pathway

The coal gasification production pathway has been divided into distinct modules to facilitate application of emissions accounting analysis through system expansion. For coal gasification, analysis is performed across three distinct modules, as follows:

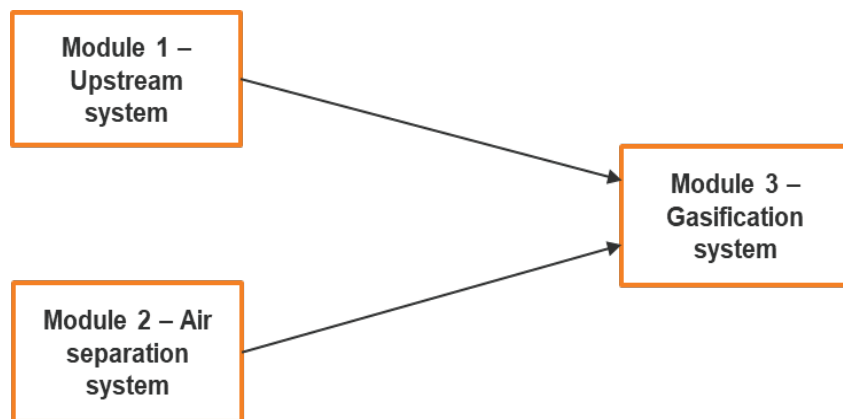

**Figure P4. 3: coal gasification production pathway**

**Module 1 (Upstream system)** – covers upstream activities associated with the extraction, processing and delivery of the coal feedstock. This system is taken out of the process as a separate module to allow treatment of this system in different ways (i.e. collection of primary and secondary data<sup>39</sup> to derive a local or regional emission factor, or use of a scope 3 emission factor that should at a minimum be country specific<sup>40</sup>). As this system has a single product,

<sup>38</sup> The impacts of hydrogen as an indirect GHG have not been considered as part of this work given current focus on (direct) GHG emissions accounting.

<sup>39</sup> As per the GHG Protocol Standard “primary data are data collected from specific processes in the studied product’s life cycle” and “secondary data are defined as data that are not from specific processes in the studied product’s life cycle”

<sup>40</sup> Note this treatment is likely dependent on the availability of data. For an integrated system where the hydrogen producer extracts and processes coal, it is reasonable that they might wish to collect primary and

no emissions allocation approaches are required and all emissions are attributed to a single output, coal for gasification. That is, all emissions associated with this system are allocated to the intermediate product: coal. These emissions are carried with the coal (as embodied emissions) into the gasification system (module 3). Where applicable assessment of module 1 may be by-passed via use of an appropriate scope 3 emissions factor covering coal supply.

### Module 1: Upstream System

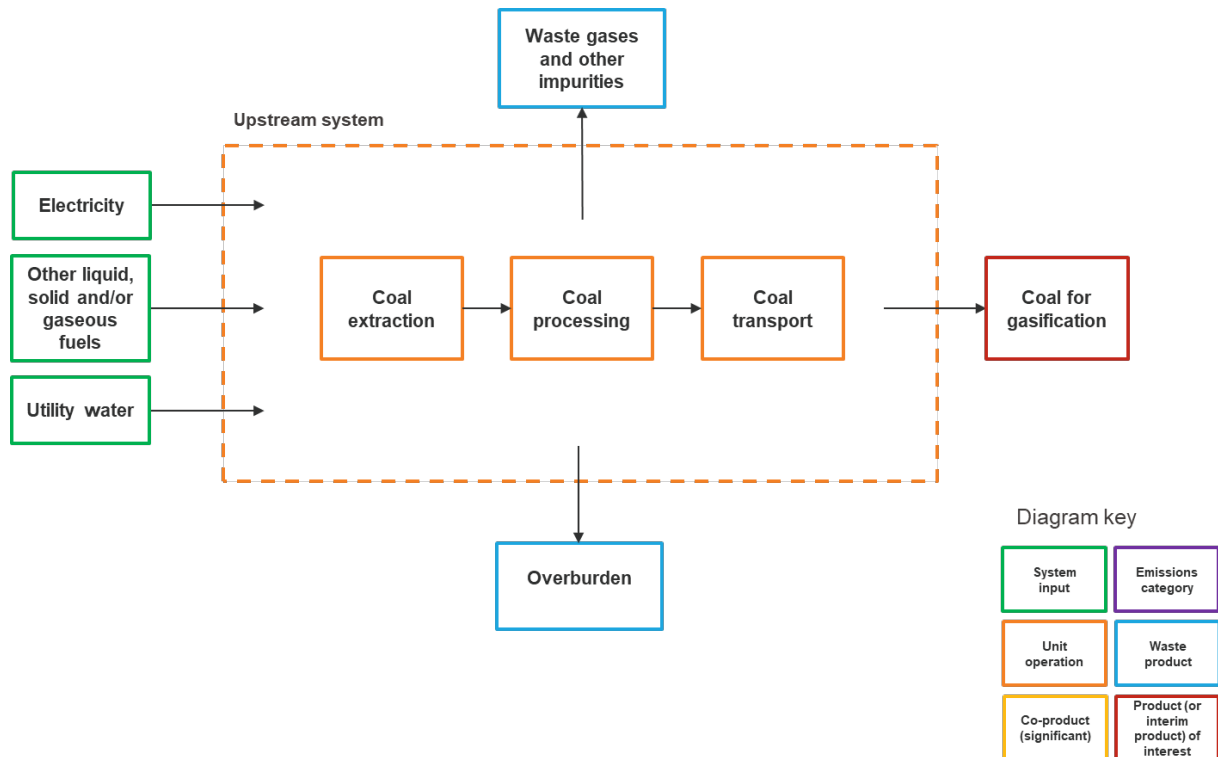

Figure P4. 4: Coal gasification upstream system

**Module 2 (Air separation system)** – covers the supply of oxygen for the coal gasification process. For module 2, there are two potential co-products (liquid nitrogen and liquid crude argon) associated with the system in addition to the intermediate product: liquid oxygen<sup>41</sup>. This system has been scoped out for allocation as, unlike the remainder of the gasification system (module 3), it cannot be resolved using methods to avoid allocation<sup>42</sup>.

The liquid nitrogen stream will be significant given its abundance relative to oxygen in air and the oxygen demands of an industrial gasifier. The argon stream will be much smaller,

secondary data to assess the upstream emissions and derive an embodied emission factor for their coal. However, if the coal is simply bought from a supplier this supplier may provide an embodied emission factor for this coal or in some cases a default embodied emission factor for coal may be identified in appropriate life cycle databases.

<sup>41</sup> Some waste heat may also be produced as the electricity is consumed.

<sup>42</sup> Process subdivision is not appropriate as the process unit cannot be broken down further. Functional unit expansion is not appropriate in the context of this work (as previously noted). System expansion is not appropriate as cryogenic air separation is a typical, system for largescale oxygen supply and a suitable alternative system is not available.

reflecting the low argon concentration in air (approximately 0.93%). One or more of these co-products may be captured and sold noting that they have a variety of common uses. Where these co-products are valorised they may be allocated some share of emissions. The priority approach is to allocate on the basis of physical relationships. The Ecoinvent database's *Life Cycle Inventories of Chemicals* outlines an approach for allocation of emissions across the three liquid products on the basis of the heat of vaporisation and heat capacity of the three liquid products assuming that the thermodynamic efficiency of the cooling and liquefaction process is the same for all three gases (Althaus, 2007). This results in an allocation factors of 22.2% for oxygen, 76.9% for nitrogen and 0.9% for crude argon.

Emissions associated with the intermediate oxygen product can be estimated as follows:

$$E_{\text{liquid oxygen}} = E_{\text{air separation}} - E_{\text{liquid nitrogen}} - E_{\text{liquid crude argon}}$$

Where  $E_{\text{liquid oxygen}}$  is the emissions associated with liquid oxygen,  $E_{\text{air separation}}$  is the total emissions associated with the air separation module (as calculated in line with the guidance provided for module emissions inventories), and  $E_{\text{liquid nitrogen}}$  and  $E_{\text{liquid crude argon}}$  are the emissions associated with the co-products as calculated using the allocation factors referred to above.

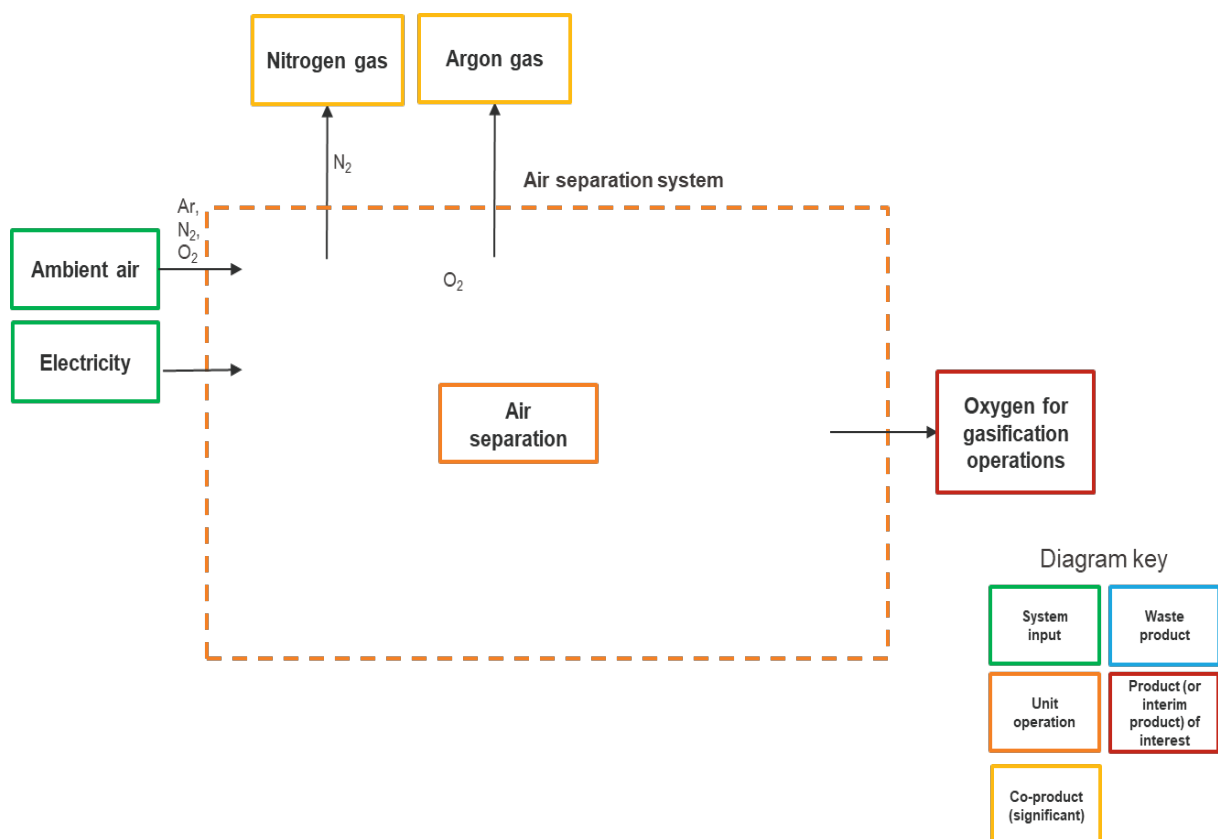

**Figure P4.5: Air separation system**

**Module 3 (Gasification system)** – covers all remaining processes including further coal processing, gasification, syngas conditioning and waste heat recovery.

For module 3, inputs include the intermediate products from modules 1 and 2, which carry an emission factor (reflecting embodied emissions).

The gasification system includes a range of potential co-products, including electricity and steam, generated via waste heat recovery, ash and/or slag recovered from the gasifier and sulphur recovered via syngas purification. The scale of production for these potential co-products remains uncertain and is likely subject to facility-specific commercial circumstances (i.e. energy costs, grid considerations, plant design and operation).

Where applicable, emissions may be scoped out for the co-products using system expansion. In order to do so, appropriate substitute systems must be identified and appropriate allocation factors established.

Electricity is likely to be an important co-product for the gasification system. Electricity exported from the system could substitute grid electricity (kWh for kWh), and emissions estimated in line with relevant grid emission factors (i.e. local, regional, national). This is a common approach in various carbon accounting schemes. Energy allocation could also be applied to this co-product.

Steam may also be an important co-product for the gasification system, but this is likely to be highly dependent on the availability of appropriate infrastructure and nearby consumers given the nature of steam supply. Currently the dominant technology for generation of high-grade steam (heat), is via combustion of natural gas within a boiler. As such, steam exported from the system could be estimated in line with the emissions associated with equivalent steam produced in a natural gas boiler of a pre-defined default efficiency (ARENA, 2016).

The ash and slag products are significantly less material. Default allocation factors should be defined here relating to appropriate substitute systems. For ash and slag, these co-products vary in uses from low-value applications such as replacing natural aggregates to high-value applications such as replacing clinker in cement production. A conservative emission factor should be established as the default, but it may be important to include measures which allow and incentivise users of the scheme to seek out higher quality data specific to their value chain.



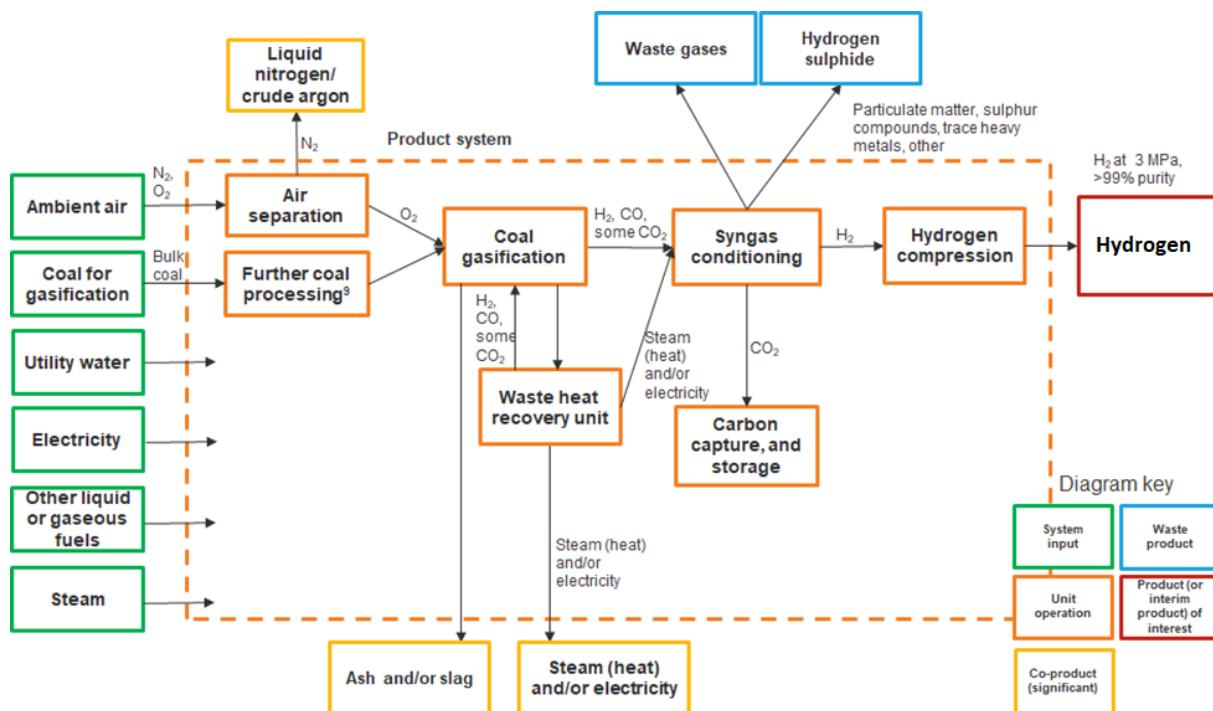

Figure P4.6: Coal Gasification system

#### P4.5. Information To Be Reported<sup>43</sup>

Category	Matters to be identified
Facility details	<ul style="list-style-type: none"> <li>Facility identity</li> <li>Facility location</li> <li>Facility capacity</li> <li>Commencement of facility operation</li> </ul>
Production	<ul style="list-style-type: none"> <li>Production pathway</li> </ul>
Product specification	<ul style="list-style-type: none"> <li>Hydrogen output pressure</li> <li>Hydrogen purity</li> <li>Contaminants</li> <li>Hydrogen quantity (kg)</li> </ul>
GHG emissions overview	<ul style="list-style-type: none"> <li>Emissions intensity of hydrogen batch</li> <li>Type of offsets used (if applicable, noting that at this stage permitting the use of offsets is contentious and not recommended)</li> <li>Quantity of offsets used (if applicable, noting that at this stage permitting the use of offsets is contentious and not recommended)</li> </ul>
Batch details	<ul style="list-style-type: none"> <li>Beginning and end of batch dates</li> <li>Batch quantity</li> </ul>
Electricity	<ul style="list-style-type: none"> <li>Location based emissions accounting <ul style="list-style-type: none"> <li>Quantity of purchased grid electricity [kWh]</li> <li>Location based emission factor used [kgCO<sub>2</sub>e/kWh]</li> </ul> </li> <li>Market based emissions accounting</li> </ul>

<sup>43</sup> In a country where GO system and residual mix system are not used for electricity emission counting, reporting of GO and residual mix related matters cannot be necessary.

	<ul style="list-style-type: none"> <li>• Quantity of purchased grid electricity [kWh]</li> <li>• Quantity of contracted renewable electricity [kWh] and/or quantity of associated GOs or RECs</li> <li>• Residual electricity [kWh]</li> <li>• Residual mix emission factor [kgCO<sub>2</sub>e/kWh]</li> <li>• Type of GOs or RECs</li> <li>• On-site electricity generation <ul style="list-style-type: none"> <li>• Quantity of on-site generation [kWh]</li> <li>• Emission factor for on-site generation (as applicable) [kgCO<sub>2</sub>e/kWh]</li> </ul> </li> </ul>
Other utilities	<ul style="list-style-type: none"> <li>• Source/s of water</li> <li>• Source/s of steam</li> <li>• Quantity of purchased water [kg]</li> <li>• Quantity of purchased steam [kg]</li> <li>• Quantity of steam exported [kg]</li> </ul>
Fuel feedstock	<ul style="list-style-type: none"> <li>• Types of fuels combusted</li> <li>• Quantities of fuel combusted [L, kg]</li> <li>• Relevant emissions calculation or factors used [kgCO<sub>2</sub>e/relevant unit of fuel]</li> <li>• Emissions intensity of fuel used, including all emissions associated with fuel extraction, transporting to a processing plant, and processing [e.g. kgCO<sub>2</sub>e/mmbtu]</li> </ul>
Process	<ul style="list-style-type: none"> <li>• Coal gasification reactor type</li> <li>• Syngas purification technology</li> <li>• Air separation technology</li> <li>• Sulphur waste gas processing technology (if applicable)</li> <li>• Quantity and type of vented GHG gases [kg]</li> <li>• Quantity and type of flared GHG gases [kg]</li> <li>• Technology for monitoring fugitives from CO<sub>2</sub> storage</li> <li>• CO<sub>2</sub> capture rate</li> </ul>
Coal feedstock	<ul style="list-style-type: none"> <li>• Type of coal</li> <li>• Coal composition</li> <li>• Quantity of coal used for gasification reactions [kg]</li> <li>• Quantity of coal used for heating [kg]</li> <li>• Embodied emission factor for coal [kgCO<sub>2</sub>e/kg] (derived from primary and secondary data, provided by supplier or sourced from relevant source i.e. NGA Factors)<sup>44</sup></li> </ul>
Carbon dioxide treatment	<ul style="list-style-type: none"> <li>• Type of CO<sub>2</sub> storage</li> <li>• Location of CO<sub>2</sub> storage</li> <li>• Transport type of CO<sub>2</sub> to storage location (if applicable)</li> <li>• Quantity of CO<sub>2</sub> captured [kg]</li> <li>• Quantity of CO<sub>2</sub> stored [kg]</li> <li>• Quantity of fugitive emissions created during injection of CO<sub>2</sub> into the storage location [kg]</li> <li>• Quantity of fugitive CO<sub>2</sub> emissions from storage [kg] (in line with defined timeline)</li> </ul>
Waste and/or co-products	<ul style="list-style-type: none"> <li>• Quantity of ash produced [kg]</li> <li>• Quantity of slag produced [kg]</li> <li>• Quantity of nitrogen produced [kg]</li> </ul>

<sup>44</sup> Note that where upstream emissions are derived using upstream data, there may be a requirement for additional information. This could include items such as coal source.

	<ul style="list-style-type: none"><li>• Quantity of crude argon produced [kg]</li><li>• Quantity of ash sold [kg]</li><li>• Quantity of slag sold [kg]</li><li>• Quantity of nitrogen sold [kg]</li><li>• Quantity of crude argon sold [kg]</li><li>• Quantity of other products [kg]</li></ul>
--	---

## Appendix P5: Hydrogen production pathway – Biomass as feedstock (with Carbon Capture and Storage - CCS)

### P5.1. Biomass definition

Biomass is organic materials derived from plants and animals, excluding material embedded in geological formations and material transformed to fossilized material. Examples of biomass include:

- Conventional food and feed crops
- Food and agricultural waste (e.g., home food waste collection)
- Perennial energy crops (e.g., Miscanthus grass) and short rotation coppice (e.g., willow/poplar)
- Short rotation forestry (e.g., birch) and forest residues (e.g., leftover from logging)
- Marine-based and novel feedstocks (e.g., algae) (BEIS, 2021).

The use of biomass for energy purposes accounts for over 10% of the global energy need, which classifies these feedstocks as the fourth energy source after oil, gas, and coal (World Bioenergy Association, 2020).

Hydrogen from biomass is a carbonless fuel alternative to other high-efficiency biomass secondary energy carriers (e.g., biofuels). Hydrogen production with CCS provides means to sequester and permanently store biogenic CO<sub>2</sub> resulting in a net decrease in atmospheric carbon (IEA, 2017). A wide range of biomass feedstocks can be used for hydrogen production, including wet organic wastes (e.g., sewage sludge, animal wastes, municipal solid waste (MSW)); residues and co-products from agroindustry and the timber industry; dedicated energy crops; and non-food crops (IEA, 2017). The current guidance focuses specifically on the use of waste biomass sources for hydrogen production.

### P5.2. Biomass waste definition

Waste products that could be used for hydrogen production vary widely in composition regionally. **In the current document, “waste” is defined as any bio-feedstock that is not deliberately produced and is otherwise unlikely to be valorized in the country of origin.**

Examples may include:

- Biogenic portion of municipal solid waste (MSW),
- animal waste,
- food industry residues,
- residue from agriculture,
- forests that would traditionally be left to decompose naturally (ICAO, 2019).

As stated above, this report provides guidance only for waste biomass sources used in H<sub>2</sub> production. It is worth noting that “waste” is not necessarily a permanent designation for a material. If additional valorized product streams were to emerge for a given type of waste material currently deemed a waste, the competition of its use for H<sub>2</sub> production could result

in upstream emissions impacts. Additionally, in the context of forestry materials, whether a product is considered a waste or a valorized product is a spectrum versus a clear delineation based on the properties of the material (e.g., corn stover versus corn kernel). A tree that was intended for timber harvest may be thinned because of some perceived defect (e.g., a curved trunk, or relatively diminutive size relative to other trees in the stand). The valorization of the “waste” material which could be considered slash and thinnings, may change the decision-making of the forest owner about the allocation of wood material to different end uses. On the margin, this could also result in changes in supply that effect decision-making for other forest owners. Acknowledging that these potential indirect emissions impacts could occur on the margin for certain waste materials over a longer time-frame, issues related to land-use change (LUC) and other sustainability considerations were outside of the scope of this document, given that the focus is on use of waste.

#### a. Determination of waste

To determine whether a feedstock is a biogenic waste, stakeholders should rely on analysis specific to the country the feedstock was sourced from. Such analysis should account for the quantity of the respective feedstock that is available in the host country, the approximate size of other markets for that feedstock, and the quantity of the feedstock expected to be used for hydrogen production, to determine whether the feedstock would otherwise have been likely to be valorized. It is worth noting that country’s legislations may encompass this definition.

#### b. Calculation of waste emissions avoidance: equations and examples

In calculating the emissions associated with biowaste products that would otherwise be disposed of (e.g. MSW that would be disposed of in landfills, or animal waste that would be disposed of in lagoons), stakeholders may attribute credits to the emissions intensity of hydrogen produced based on estimates of GHG emissions of a counterfactual scenario where those wastes would be disposed of.

Regarding hydrogen production, avoided GHG emissions from organic waste feedstock are mainly from CH<sub>4</sub> emissions from decay of organic matter and indirect CO<sub>2</sub> emissions from methane oxidation in the counterfactual scenario.

To determine the value of avoided emissions, stakeholders must first identify an appropriate counterfactual scenario for the region where the feedstock would likely have been disposed of if it were not utilized for hydrogen production.

#### Equation 1:

Equation 1 is an approach to determining the value of a credit for avoided methane emissions that would traditionally be released into the atmosphere. Avoided methane emissions are estimated by subtracting the amount of methane emissions mitigated (e.g. through combustion for power generation, flaring, or oxidation) from the amount of methane emissions generated (adapted from (Dong et al., 2006))

$$CH_{4,emission\ credit} = CH_{4,generation} - CH_{4,mitigated}$$

The “ $CH_{4,generation}$ ” parameter reflects the amount of methane generated by the decay of the organic waste feedstock. The “ $CH_{4,mitigated}$ ” parameter reflects that amount of the  $CH_{4,generation}$  that would likely have been mitigated in the counterfactual scenario (e.g., through combustion for power generation, flaring, or oxidation). When waste feedstock is being sourced from a region where its disposal would likely have required methane mitigation due to regional regulations, an estimate of the amount of methane generation that would have to be mitigated for regulatory compliance must be accounted for in  $CH_{4,mitigated}$ .

### Equation 2:

Organic waste feedstock results in carbon dioxide emissions, due partly to decay of the organic matter and partly due to methane mitigation measures at a predefined site in the counterfactual scenario. Carbon dioxide emissions of organic matter are estimated by summing estimates of direct CO<sub>2</sub> emissions with estimates of CO<sub>2</sub> generation from methane oxidation (Lee et al., 2016).

$$CO_{2,emission} = CO_{2,generation} + CO_{2,mitigation}$$

### Municipal Solid Waste:

One traditional approach to the disposal of MSW is its storage in landfills, where the MSW will eventually decompose to produce GHGs<sup>45</sup>. However, landfill emissions may be mitigated, often to comply with regional regulations, by flaring methane, oxidizing methane into carbon dioxide, or burning methane for power generation (Dong et al., 2006; Lee et al., 2016). Alternatively, this methane can be used for hydrogen production through thermochemical conversion.

### Equation 3:

The quantity of methane generation through the decay of MSW in landfills is typically estimated using first-order decay models, such as Equation 3 (IPCC, 2001). Stakeholders may use such models to estimate the value of  $CH_{4,generation}$  in Equation 1.

$$CH_{4,generation\ in\ year\ t} \left( \frac{Gg}{yr} \right) = \sum_x [(A \cdot k \cdot MSW_T(x) \cdot MSW_F(x) \cdot L_0(x)) \cdot e^{-k(t-x)}]$$

For x = initial year to t

t = year of inventory

X = years for which input data should be added

A =  $(1 - e^{-k})/k$ ; normalization factor which corrects the summation. *The IPCC recommends values of k*

k = Methane generation constant (1/year). Countries may have values of k specific to regional waste profiles and conditions at landfills.

*The IPCC recommends default values of k where region-specific values based on historical data are not available.*

MSW<sub>T</sub>(x) = Total MSW generated in year x (Gg/year)

MSW<sub>F</sub>(x) = Fraction of MSW disposed at landfill in year X

L<sub>0</sub>(x) = Methane generation potential (MCF(x) • DOC(x) • DOCF • F • 16/12 (Gg CH<sub>4</sub>/Gg waste))

MCF(x) = Methane correction factor in year x (fraction)

DOC (x) = Fraction of degradable organic carbon (DOC) in year x (Gg C/Gg waste) *The IPCC provides guidance for values of DOC given different types of waste*

DOCF = Fraction of DOC dissimilated

F = fraction by volume of CH<sub>4</sub> in landfill gas

16/12 = conversion from C to CH<sub>4</sub>

<sup>45</sup> The rate of GHG production from MSW decay at a landfill depends largely on the composition of the waste (as different waste products will have different carbon content and decay rates), moisture content of the waste, and whether the landfill design is largely aerobic or anaerobic.

### Animal feedstock waste and agriculture

Traditional disposal of animal manure occurs in lagoons. Some lagoons currently capture methane generated and then burn the methane for power generation, but in most cases, methane that is generated is emitted into the atmosphere.

Agriculture waste from large scale agriculture production is normally regulated by local legislation, which may require adopting treatments that results in the production of organic fertilizers and soil conditioners. Agriculture waste treatment includes composting and biodegestion, and both are a mean to promote nutrient recycling and protect the soil against erosion and nutrient loss.

As above, when a credit is being calculated to reflect avoided emissions from animal or agriculture waste, the value of the credit must account for local regulations that would have mitigated GHG emissions from lagoons or composts in the region the feedstock would likely have been disposed in. CO<sub>2</sub> emitted from biogas formation and agriculture waste incineration are biogenic<sup>46</sup>, thus, do not increase total CO<sub>2-eq</sub> in the atmosphere.

To estimate avoided emissions from animal waste, it is recommended that stakeholders follow IPCC guidance (Dong et al., 2006).

### P5.3. Biomass-Based Hydrogen Routes: General Process Description

Biomass usually has an intricate structure consisting of approximately 6% hydrogen (on a mass basis) in contrast to methane which is 25% hydrogen, for example (Milne et al., 2002). Several highly endothermic processes can be applied to effectively produce hydrogen from different organic matter, leading to significant differences in environmental and energy performances of biomass-to-hydrogen systems (Hallenbeck and Benemann, 2002; Krzysztof J. Ptasiński, 2008; Kalinci et al., 2009).

Biomass-to-hydrogen processes can be divided into two different categories (Hosseini and Wahid, 2016; Nikolaidis and Poullikas, 2017; Blasi et al., 2020):

1. thermochemical pathways including pyrolysis, liquefaction, or gasification followed by bio-oil upgrading and reforming, or syngas upgrading and biomethane reforming;
2. the biological pathways including water–gas shift reactions promoted by microorganisms, photo-fermentation and dark-fermentation, anaerobic digestion and biomethane upgrading, and bio-photolysis with photosynthetic organisms (microalgae and cyanobacteria) such as microbial electrolysis cells.

Thermochemical pathways aim to promote cracking reactions under severe thermodynamic conditions, so to breakdown biomass molecules into lower molecular weight polymers and hydrogen-rich gases. Biological routes provide alternative methods of hydrogen production since they can be operated at ambient temperatures and pressures, therefore being less energy-intensive compared to thermochemical processes (Singh and Wahid, 2015).

---

<sup>46</sup> It is worth noting that fugitive biomethane emissions cannot be re-absorbed by plants.

This document presents two hydrogen production pathways: biomass gasification and biogas reforming, which are currently ready at commercial level. Biogas plants and gasification units are mostly at a small scale with limited resources of biomethane and producer gas, respectively. This hampers the implementation of large hydrogen production, differently than their fossil-plants counterparts. Thus, despite a high TRL, they do not yet match the available technologies for hydrogen production at scale for industrial oil refineries and ammonia plants, such as the natural gas SMR.

The present analysis considers two different hydrogen production routes described as follow and summarized in **Figure P5.1**.

1. Biodigestion route: (a) feedstock pre-treatment, (b) biodigestion and biogas pre-treatment (c) reforming (biomethane or dry reforming), (d) high-temperature shift reactor and (e) pressure swing absorption (PSA).
2. Gasification:
  - A. Gasification with combustion: (a) feedstock pre-treatment, (b) gasification and combustion (c) reforming, (d) high-temperature shift reactor and (e) pressure swing absorption (PSA).
  - B. Gasification without combustion: (a) feedstock pre-treatment, (b) gasification (c) high-temperature shift reactor and (d) pressure swing absorption (PSA).

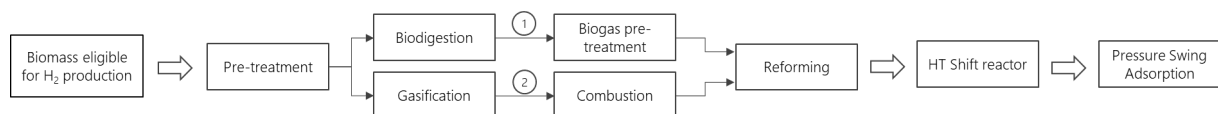

**Figure P5.1: Hydrogen from Biomass - General Overview**

In the biomass-to-hydrogen route, biogenic  $\text{CO}_{2\text{eq}}$  emissions are produced during the gas processing in the pre-treatment phase, the reforming and high-temperature reactions, and the separation in the pressure swing adsorption phase. Non-biogenic  $\text{CO}_2$  emissions may be associated with feedstock transportation, electric grid energy mix, and other energy inputs for the production system.

As most hydrogen production from biomass is still in the early commercial stage, it is difficult to define standardized production pathways, especially for cases that include CCS. However, due to similarities to coal gasification and SMR processes, their associated carbon capture technologies and processes can be used for biomass-to-hydrogen pathways. Depending on the facility and the biomass conversion process,  $\text{CO}_2$  can be captured by different means such as chemical solvents (mono-ethanol amine (MEA), methyl-diethanol amine (MDEA)), physical solvents (Selexol system) and pressure swing adsorption (PSA).

It is worth to mention that hydrogen produced with renewable electricity generated from biomass sources is out of the scopes of the present document as it is treated within the task related to the hydrogen production from electrolysis.



## P5.4. Biodigestion / CCS Process Description

Organic feedstocks available for biogas production are mainly agriculture waste, animal manure, sewage sludge and disposed organic waste in landfills. Biogas, which is majorly composed of 40-65% of  $\text{CH}_4$  and 35-55% of  $\text{CO}_2$ , results from the anaerobic digestion of organic feedstocks in absence of oxygen and without energy supply. Other components, such as hydrogen sulfide ( $\text{H}_2\text{S}$ ), oxygen, nitrogen, moisture, siloxanes, ammonia, can also be found in minor portions and are removed during the pre-treatment stage. The final desired biogas composition varies according to the reforming technologies utilized. For instance, biogas upgrading is required before biomethane SMR (Figure P5. 3), whereas dry reforming benefits from moisture content in raw biogas (Figure P5. 4).

**Module 1 (upstream system)** covers upstream activities associated with the pre-treatment of the feedstock, its transportation, extraction, and processing until obtaining raw biogas or biogas mixture. A potential co-product from this process is feedstock for fertilizer, which consists of solid and/or liquid matter derived from this process. The scope of this work only considers the anaerobic digestion of organic wastes.

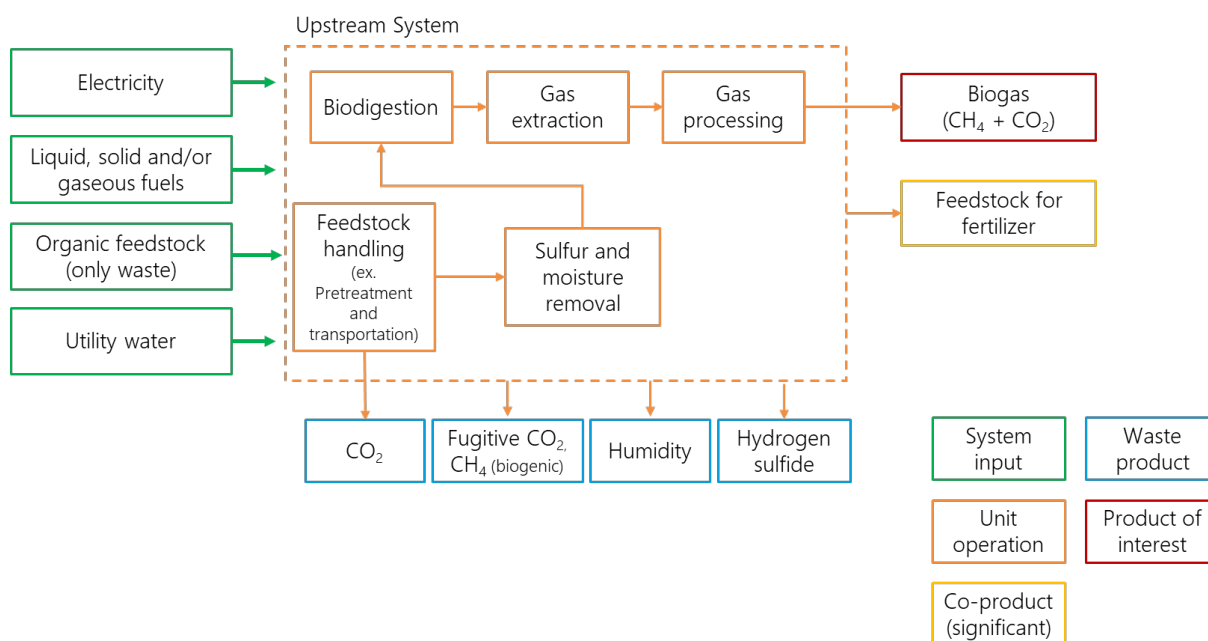

**Figure P5. 2: Process diagram for the upstream system to deliver biogas mixture for upgrading and/or reforming**

**Module 2 (production system)** The base case consists of two different processes. First (module 2a) biomethane steam methane reforming: (a) biogas mixture heating and pressurization, (b) pre-reformer (desulphurization and moisture removal), (c) primary reformer (SMR), (d) high-temperature shift reactor and (e) pressure swing absorption (PSA). Carbon capture and storage relates to biogenic  $\text{CO}_2$ .

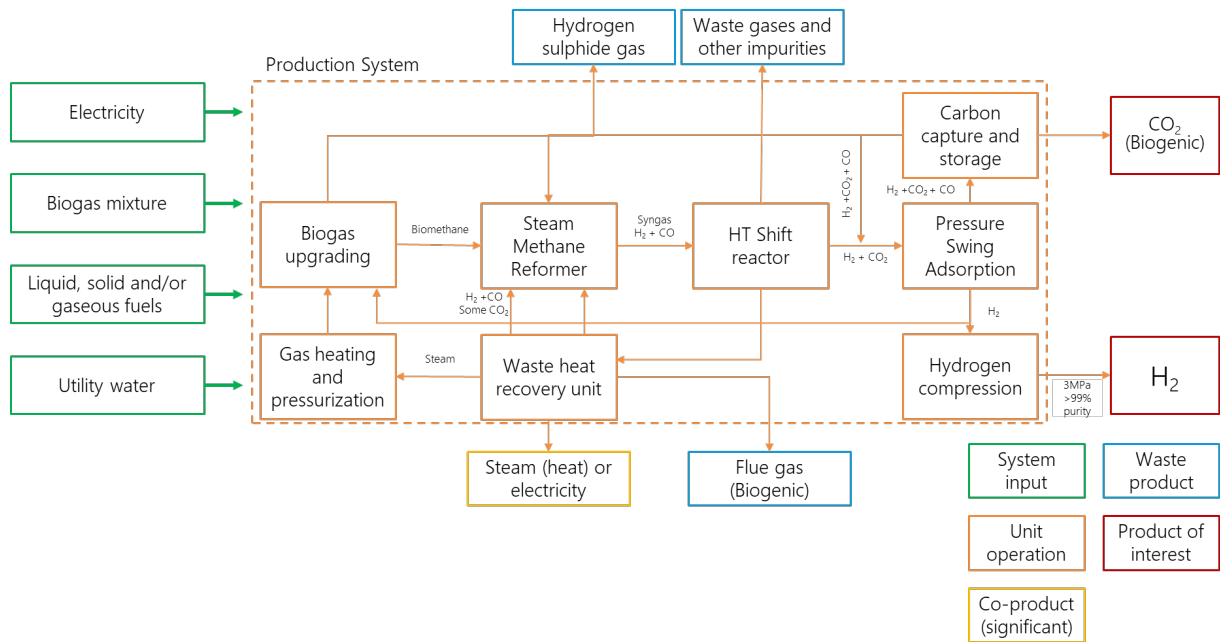

**Figure P5. 3: Process diagram for hydrogen produced from SMR/CCS**

Second (module 2b) Dry reforming: (a) biogas mixture heating and pressurization, (b) pre-reformer (desulphurization), (c) dry reformer (biogas), (d) high temperature shift reactor and (e) pressure swing absorption (PSA). Carbon capture and storage relates to biogenic CO<sub>2</sub>.

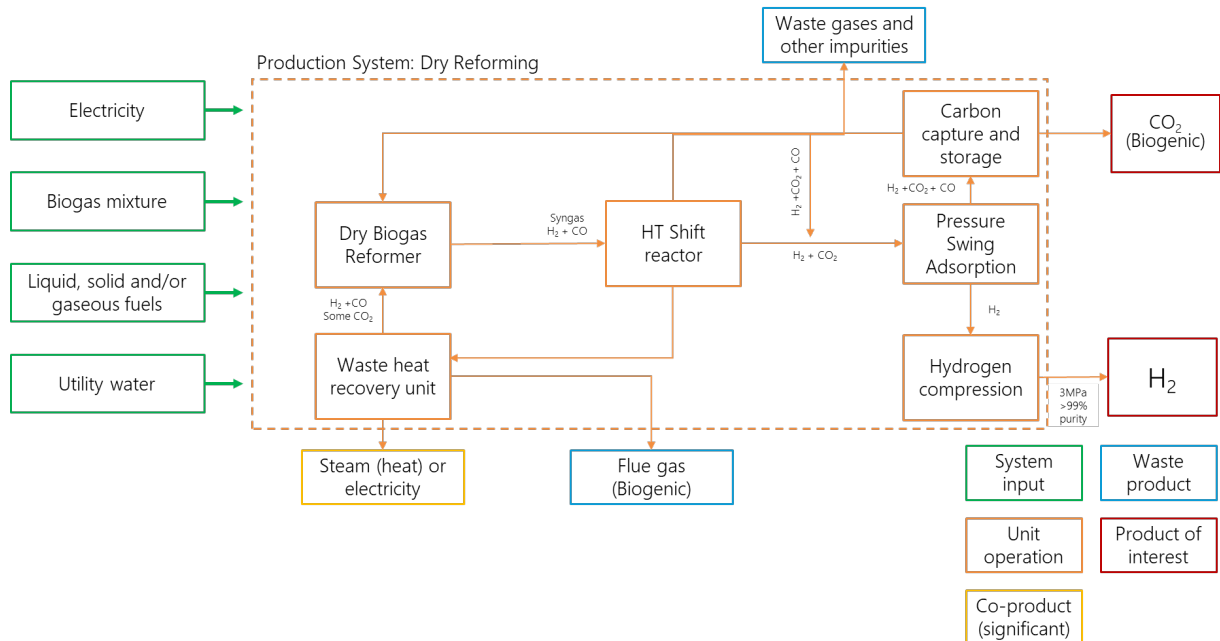

**Figure P5. 4: Process diagram for hydrogen produced from Dry Reforming/CCS**

For both biogas reforming routes (module 2a and b), co-products can be electricity, steam and/or carbon monoxide (pending the nature of the individual production facility).

## P5.5. Gasification /CCS Process Description

Gasification is the thermochemical conversion of a solid fuel into a product gas (also referred to as producer gas) in presence of a specific gasification agent, commonly air. A biogenic carbon-based material, such as biomass and wastes, is partially combusted to generate heat (in general from 700 to 1200°C), which release product gas (e.g., CO, CO<sub>2</sub>, H<sub>2</sub>, CH<sub>4</sub> and other light HCs), some harmful gases, and other residuals.

Gasification can be performed in either single step, or multi-step processes, based on both fixed and/or fluidized bed reactors. For subsequent steps, gas cleaning and upgrading are necessary in order to remove trace components like H<sub>2</sub>S, NH<sub>3</sub>, HCl, as well as other residuals (depending on the feedstock and processing conditions). Adding water/steam as a gasification agent is a common practice to increase H<sub>2</sub> production, enhance char gasification and moderate the reactor temperature. The reforming process is similar to SMR of methane. The major unit operations are a primary reformer to convert methane and the higher hydrocarbons present in the product gas to syngas, plus shift reaction to convert syngas and steam to hydrogen. The purification section is the last conversion step, i.e., Pressure Swing Absorption (PSA) reactor, which typically requires at least 70 mol% hydrogen in the input stream (Koroneos et al., 2008). Therefore, the flue (tail) gas from the PSA unit is recycled and combusted to provide heat for the gasification and steam reforming processes. More detailed descriptions of biomass gasification-to-H<sub>2</sub> processes, including detailed LCA studies, are reported in the works of (Moreno and Dufour, 2013; Muresan et al., 2014; Martín-Gamboa et al., 2016). In the present section, the conversion pathways have been elaborated by following the processes layout reported in (Kabir and Kumar, 2011; Simons and Bauer, 2011; Prussi et al., 2020), based on the gasifiers described in (Binder et al., 2018).

### Module 1 (upstream system)

Covers upstream activities associated with the pre-treatment of the feedstock, its transportation, extraction, and processing until obtaining biomass with specifications and moisture content suitable for the next gasification process. In Module 1, farmed or waste wood is used as the example for biomass feedstock, but in some cases also herbaceous biomass or the organic fraction of MSWs could be considered as feedstock.

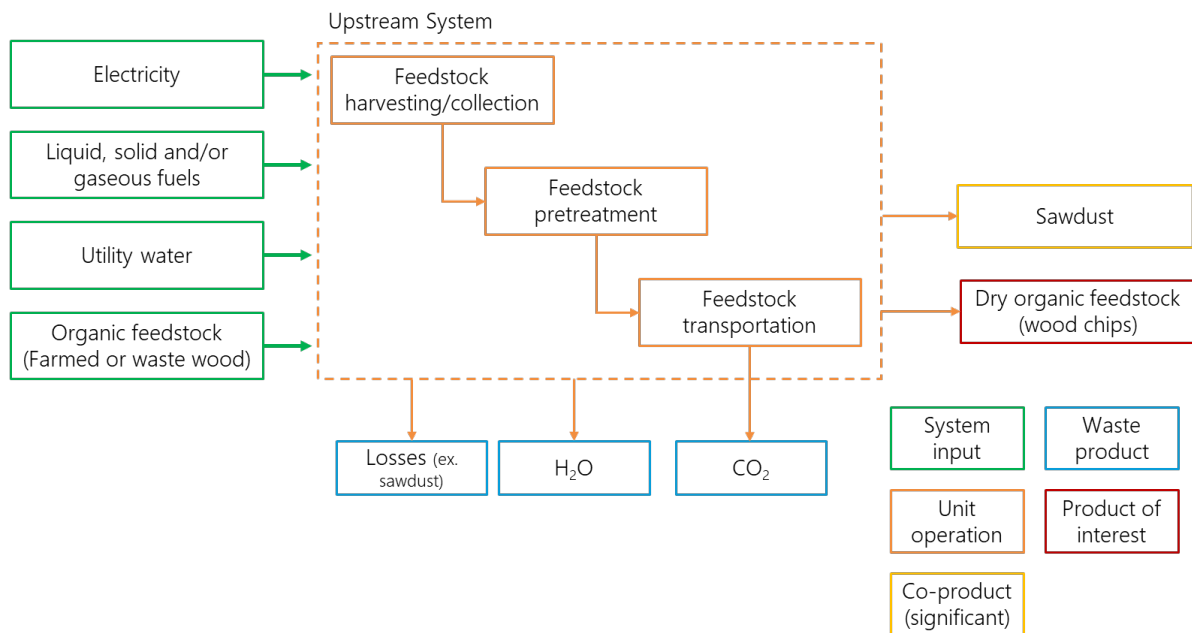

**Figure P5. 5: Process diagram for the upstream system to pretreat wood to wood chips for gasification processes**

### Module 2 (production system)

Module 2 comprises two different processes layout, based on: traditional gasification (single step unit) [module 2a in **Figure P5. 6**], which delivers first the product gas to a steam reformer, followed by a shift reactor and ending with hydrogen purification section in PSA; a double step gasifier based on a fluidized bed [module 2b in **Figure P5. 7**], which deliver a cleaner gas (compared to the previous case), i.e., syngas from partial combustion of product gas, directly to the shift reactor followed by the hydrogen purification section. The latter process includes the use of catalysts.

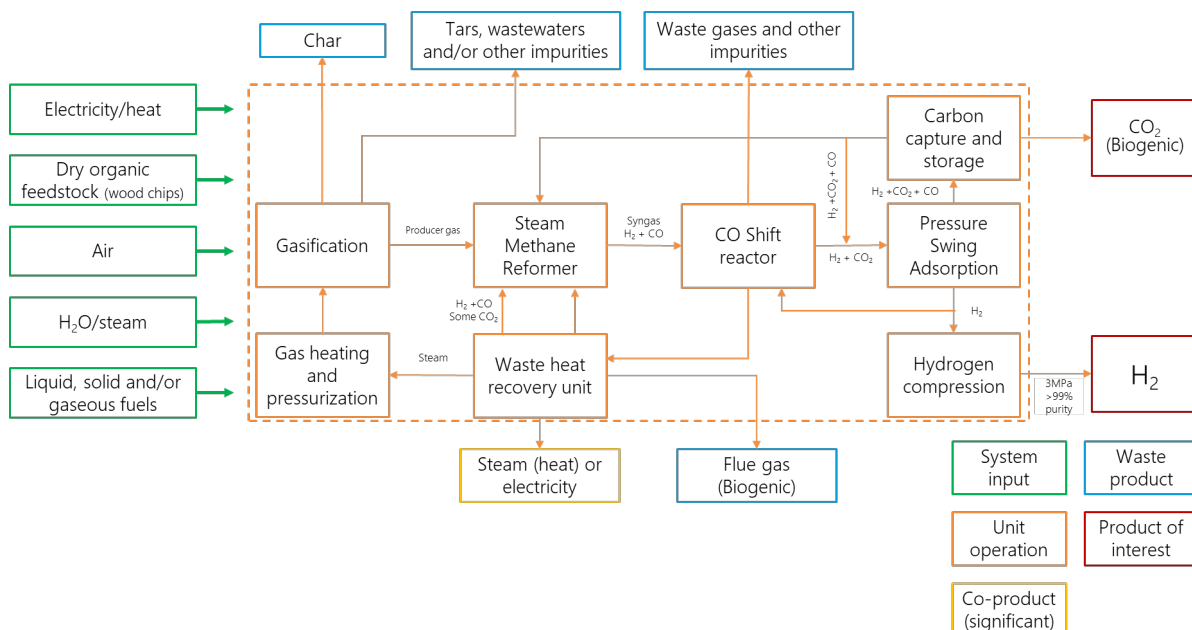

**Figure P5. 6: Production System based on Gasification, Reforming, Shift and PSA**

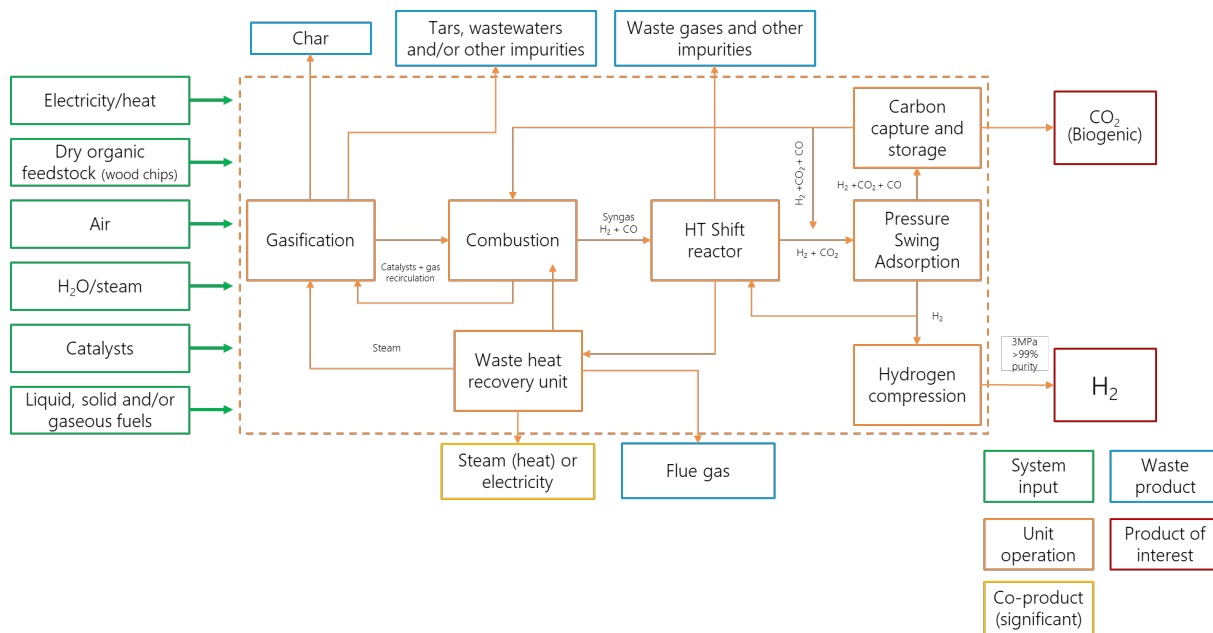

**Figure P5. 7: Production System based on absorption enhanced reforming (AER) gasification, shift reactor and PSA**

### P5.6. Emissions sources in Biomass-Based Hydrogen Routes/CCS

For biomass-based hydrogen routes with CCS, the main source of GHG emissions is the CO<sub>2</sub> resulting from the gasification processes. However, differently from natural gas SMR or coal gasification, the CO<sub>2</sub> emission from biomass gasification is biogenic, therefore does not increase the net amount of atmospheric CO<sub>2</sub>. Other significant emission sources include the scope 2 emissions of grid electricity, energy used for CO<sub>2</sub> removal process, and energy used for CCS. Each processing unit or stage in the biomass-based hydrogen routes contains unique emissions sources as outlined in **Table P5. 1**.

**Table P5. 1: GHG emissions summary for biomass-based hydrogen routes /CCUS**

Process unit/stage	Key emissions sources	Other emissions sources
Organic feedstock processing	<ul style="list-style-type: none"> <li>Electricity and/or fuel combustion for feedstock extraction, treatment, and movement</li> <li>Fugitive biomethane and/or biogenic carbon dioxide from biogas mixture leakage /decay of organic feedstock</li> </ul>	
Biomass feedstock transport	<ul style="list-style-type: none"> <li>Electricity and/or liquid fuel combustion for materials movement</li> <li>Biomethane leakage</li> </ul>	
Air separation	<ul style="list-style-type: none"> <li>Electricity for air compression (needed for gasification process)</li> </ul>	
Gasification	<ul style="list-style-type: none"> <li>Combustion of dry biomass within the gasifier (biogenic)</li> </ul>	

	<ul style="list-style-type: none"> <li>Gasification of dry biomass within the gasifier (biogenic)</li> </ul>	
	<ul style="list-style-type: none"> <li>Steam for gasification (if purchased from a third party rather than self-generated)</li> </ul>	
Heat recovery for steam or electricity generation	<ul style="list-style-type: none"> <li>No significant emissions other than those covered under common emissions sources</li> </ul>	Potential co-product credits if exported
Hydrogen enrichment	<ul style="list-style-type: none"> <li>Water-gas shift reactions occurring as part of hydrogen enrichment (biogenic CO<sub>2</sub>)</li> </ul>	
Sngas purification	<ul style="list-style-type: none"> <li>Electricity and/or heat for operation of the relevant purification units</li> </ul>	
CO <sub>2</sub> capture and separation	<ul style="list-style-type: none"> <li>Electricity and/or heat for relevant separation units</li> </ul>	
Compression and transportation of CO <sub>2</sub>	<ul style="list-style-type: none"> <li>Electricity and/or gaseous fuel combustion for CO<sub>2</sub> compression needed for pipeline transport</li> <li>Liquid and/or gaseous fuel combustion for mobile transport</li> <li>Fugitive CO<sub>2</sub> from mobile transportation of CO<sub>2</sub></li> </ul>	
Storage of CO <sub>2</sub>	<ul style="list-style-type: none"> <li>Electricity for injection or transformation</li> </ul>	Fugitive CO <sub>2</sub> from a permanent storage location
Hydrogen compression and storage	<ul style="list-style-type: none"> <li>Electricity for compression and storage</li> </ul>	Fugitive hydrogen emissions <sup>47</sup>

## P5.7. Allocation for the Biomass/CCS pathway

The present analysis showed how existing biomass pathways can be part of hydrogen production with the addition of a final conversion stage in the gas upgrading section. This leads to complex value chains including different technologies at different TRL and commercial maturity. Therefore, the energy and environmental assessments need large life cycle inventory (LCI) and harmonized methodologies for consistent evaluation. Several studies in the literature investigated the LCA performances of biomass-to-H<sub>2</sub> pathways, which generally followed the guidance of the ISO LCA methodology, ISO 14040-14067 (International Organization for Standardization, 2006).

The hydrogen production case studies and methods proposed within this document provide the guidelines to a calculation method for production processes with multiple outputs. With regards to the work done in support to IPHE, the main recommendations to perform a full LCA study of biomass-to-H<sub>2</sub> pathways are reported here below.

1. The need for system boundary definition, which avoids the allocation of GHGs emissions among co-products, wherever possible.
2. When allocation for GHGs cannot be avoided, it should follow 6.3.3.6.

<sup>47</sup> The impacts of hydrogen as an indirect GHG have not been considered as part of this work given current focus on (direct) GHG emissions accounting.

- ISO guidelines specify that, if allocation cannot be avoided, the inputs and outputs of the system should be partitioned between its different products or functions in a way that reflects the underlying physical relationships between them (e.g., allocation by energy shares in the various products)
  - When co-products with no-, or negligible, energy content result from the process, other allocation options could be considered, following ISO guidelines
  - Allocation approaches can be applied in cascade, and no single choice have to be made, in the attempt to cover a very broad spectrum of possibilities.
3. Inclusion of GHG emissions from the use of electricity and energy inputs for hydrogen production in the calculation of hydrogen-related GHG emissions (e.g., including upstream fuel supply chain emissions, emissions from the production of electricity, emissions associated with electricity transmission and distribution losses).

As regards CCS strategies, this document is consistent with the guidelines previously proposed in this document.

#### P5.8. Information to be reported

Category	Matters to be identified
Facility details	<ul style="list-style-type: none"> <li>• Facility identity</li> <li>• Facility location</li> <li>• Facility capacity (Nm<sup>3</sup>/h, t/h)</li> <li>• Capacity Factor</li> <li>• Commencement of facility operation</li> <li>• Main climatic and meteorological data (Atmospheric pressure, average ambient temperature, average relative humidity)</li> </ul>
Production	<ul style="list-style-type: none"> <li>• Feedstock and production technology pathway</li> </ul>
Product Specifications	<ul style="list-style-type: none"> <li>• Hydrogen pressure</li> <li>• Hydrogen purity</li> <li>• Contaminants</li> </ul>
GHG emissions overview	<ul style="list-style-type: none"> <li>• Emissions intensity of hydrogen batch [kgCO<sub>2</sub><sub>eq</sub>/kgH<sub>2</sub>]</li> <li>• Type of offsets used (if applicable, noting that at this stage permitting the use of offsets is contentious and not recommended)</li> <li>• Quantity of offsets used (if applicable, noting that at this stage permitting the use of offsets is contentious and not recommended)</li> </ul>
Batch details	<ul style="list-style-type: none"> <li>• Beginning and end of batch dates</li> <li>• Batch quantity</li> </ul>
Electricity	<p>Location based emissions accounting</p> <ul style="list-style-type: none"> <li>• Quantity of purchased grid electricity [kWh]</li> <li>• Location based electricity emission factor used [kgCO<sub>2</sub><sub>eq</sub>/kWh]</li> <li>• Quantity of sold (exported) electricity [kWh]</li> </ul> <p>Market based emissions accounting</p> <ul style="list-style-type: none"> <li>• Quantity of total purchased grid electricity [kWh]</li> <li>• Quantity of contracted renewable electricity [kWh] and/or quantity of associated GOs or RECs</li> </ul>

	<ul style="list-style-type: none"> <li>• Residual electricity (total – renewable) [kWh]</li> <li>• Residual mix emission factor [<math>\text{kgCO}_2_{\text{eq}}/\text{kWh}</math>]</li> <li>• Type of GOs or RECs</li> </ul> <p>On-site electricity generation</p> <ul style="list-style-type: none"> <li>• Quantity of on-site generation [kWh]</li> <li>• Emission factor for on-site generation (as applicable) [<math>\text{kgCO}_2_{\text{eq}}/\text{kWh}</math>]</li> </ul>
Other utilities	<ul style="list-style-type: none"> <li>• Source/s of water</li> <li>• Source/s of steam</li> <li>• Catalysts [kg]</li> <li>• Quantity of purchased water [kg]</li> <li>• Quantity of purchased steam [kg]</li> <li>• Quantity of steam exported [kg]</li> </ul>
Biomass feedstock conversion	<ul style="list-style-type: none"> <li>• Type of biomass feedstock</li> <li>• GHG credits from counterfactual scenario (applicable to waste biomass only)</li> <li>• Composition and properties of biomass feedstock</li> <li>• Quantity of feedstock input [kg]</li> <li>• Quantity of biogas mix produced (kg)</li> <li>• Composition of biogas mix</li> <li>• Types of process fuels combusted</li> <li>• Quantities of fuel combusted [L, kg]</li> <li>• Relevant emissions calculation or factors used [<math>\text{kgCO}_2_{\text{eq}}/\text{relevant unit of fuel}</math>]</li> </ul>
Process: Biogas upgrading	<ul style="list-style-type: none"> <li>• Biogas mix purification technology</li> <li>• Sulphur waste gas processing technology (if applicable)</li> <li>• Contaminant removal technology</li> <li>• Wastes treatment/storage technology (if applicable)</li> <li>• Quantity and type of vented GHG gases [kg]</li> <li>• Quantity and type of flared GHG gases [kg]</li> <li>• Quantity of biogas mix input [kg]</li> <li>• Quantity of purified biogas produced [kg]</li> <li>• Composition of produced biogas</li> <li>• Type of process fuel(s) used</li> <li>• Quantity of process fuel(s) used</li> </ul>
Process: Gasification	<ul style="list-style-type: none"> <li>• Gasification reactor type</li> <li>• Air separation technology (if applicable)</li> <li>• Contaminant removal technology</li> <li>• Sulphur waste gas processing technology (if applicable)</li> <li>• Wastes treatment/storage technology (if applicable)</li> <li>• Quantity and type of vented GHG gases [kg]</li> <li>• Quantity and type of flared GHG gases [kg]</li> </ul>
Process: Hydrogen production	<ul style="list-style-type: none"> <li>• Quantity of biogas used for SMR reactions [kg]</li> <li>• Quantity of biogas used for heating [kg]</li> <li>• Quantity of biogas used for producing steam [kg] (if applicable)</li> <li>• Quantity of biogas input [kg]</li> <li>• Quantity of hydrogen produced [kg]</li> <li>• Type of process fuel(s) used</li> <li>• Quantity of process fuel(s) used</li> </ul>



	<ul style="list-style-type: none"> <li>Embodied emission factor for biogas [<math>\text{kgCO}_2\text{eq/kg}</math>] (derived from primary and secondary data, provided by the supplier or sourced from relevant source i.e. NGA Factors)<sup>48</sup></li> </ul>
Dry biomass feedstock (wood)	<ul style="list-style-type: none"> <li>Type of wood</li> <li>Particle size [m]</li> <li>Moisture content [%mc]</li> <li>Mass flow [kg/h]</li> <li>Energy flow [MJ/h]</li> <li>Emission factor for wood production</li> <li>Biomass physical pre-treatment technology</li> <li>Biomass dryer or storage technology</li> </ul>
Carbon dioxide treatment	<ul style="list-style-type: none"> <li>Type of <math>\text{CO}_2</math> storage</li> <li>Location of <math>\text{CO}_2</math> storage</li> <li>Transport type of <math>\text{CO}_2</math> to storage location (if applicable)</li> <li>Type of CCS energy/fuel(s) used</li> <li>Quantity of energy/process fuel(s) used</li> <li>Quantity of <math>\text{CO}_2</math> captured [kg]</li> <li>Quantity of <math>\text{CO}_2</math> stored [kg]</li> <li>Quantity of <math>\text{CO}_2</math> sold [kg]</li> <li>Quantity of fugitive emissions created during injection of <math>\text{CO}_2</math> into the storage location [kg]</li> <li>Quantity of fugitive <math>\text{CO}_2</math> emissions from storage [kg] (in line with defined timeline)</li> </ul>
Waste or co-products	<ul style="list-style-type: none"> <li>Quantity of <math>\text{H}_2\text{S}</math> produced [kg] (biodigestion only)</li> <li>Quantity of water produced [kg] (gasification only)</li> <li>Quantity sawdust of produced [kg] (gasification only)</li> <li>Quantity of char produced [kg] (gasification only)</li> <li>Quantity of tar produced [kg] (gasification only)</li> <li>Quantity of steam produced</li> <li>Quantity of electricity produced</li> <li>Quantity of flue gas produced</li> <li>Quantity of other wastes or co-products</li> </ul>

## P5.9. References

- BEIS. (2021) Biomass Policy Statement. no.November45.
- *Hydrogen from biomass gasification - IEA Bioenergy Task 33 Report* (2018, Paris (France)). 2018. Ed. Binder, M., Kraussler, M., Kuba, M., Luisser, M., Rauch Herausgeber, R. Paris (France),
- Blasi, A., Fiorenza, G., Verardi, A. (2020). *3 - Hydrogen from biomass*. Ed. Institute on Membrane Technology of the Italian National Research Council (CNR-ITM). Rende, CS, Italy: Elsevier Inc.
- *Comparison of Biofuel Life Cycle Analysis Tools - Phase 2, Part 1: FAME and HVO/HEFA* (2018, Paris (France)). 2018. Ed. Bonomi, A., Klein, B.C., Chagas, M.F., Souza, N.R.D. Paris (France),
- *Comparison of Biofuel Life Cycle Analysis Tools - Phase 2, Part 2: biochemical 2G ethanol* (2019, Paris (France)). 2019. Ed. Bonomi, A., Klein, B.C., Chagas, M.F., Souza,

<sup>48</sup> Note that where upstream emissions are derived using upstream data, there may be a requirement for additional information. This could include items such as coal source.

- N.R.D. Paris (France),
- Borole, A.P., Greig, A.L. (2019) Life-Cycle Assessment and Systems Analysis of Hydrogen Production In Biohydrogen s.l.: s.e.: pp. 485–512.
  - Dong, H., Mangino, J., McAllister, T.A., Hatfield, J.L., Johnson, D.E., Bartram, D., Gibb, D., Martin, J.H. (2006) Emissions from livestock and manure management In IPCC Guidelines for National Greenhouse Gas inventories
  - Hallenbeck, P.C., Benemann, J.R. (2002) Biological hydrogen production; Fundamentals and limiting processes. *International Journal of Hydrogen Energy*, **27**, 1185–1193.
  - Hosseini, S.E., Wahid, M.A. (2016) Hydrogen production from renewable and sustainable energy resources: Promising green energy carrier for clean development. **57**, 850–866.
  - ICAO. (2019) CORSIA Methodology For Calculating Actual Life Cycle Emissions Values. no.March.
  - *Technology Roadmap: Delivering Sustainable Bioenergy* (2017, Paris). 2017. Ed. IEA. Paris,
  - International Organization for Standardization. (2006) "ISO 14040:2006 Environmental Management - Life Cycle Assessment - Principles and Framework". In Págs. 20.
  - IPCC (2001) Waste In Good Practice Guidance and Uncertainty Management in National Greenhouse Gas Inventories Montreal: Intergovernmental Panel on Climate Change (IPCC).
  - Kabir, M.R., Kumar, A. (2011) Development of net energy ratio and emission factor for biohydrogen production pathways. *Bioresource Technology*, **102**, 8972–8985.
  - Kalinci, Y., Hepbasli, A., Dincer, I. (2009) Biomass-based hydrogen production: A review and analysis. *International Journal of Hydrogen Energy*, **34**, 8799–8817.
  - Koroneos, C., Dompros, A., Roumbas, G. (2008) Hydrogen production via biomass gasification-A life cycle assessment approach. *Chemical Engineering and Processing: Process Intensification*, **47**, 1261–1268.
  - Krzysztof J. Ptasiński. (2008) Efficiency analysis of hydrogen production methods from biomass. *Int. J. Alternative Propulsion*, **2**, 1601–1608.
  - Lee, U., Han, J., Wang, M. (2016) Well-to-Wheels Analysis of Compressed Natural Gas and Ethanol from Municipal Solid Waste. 2016.
  - Martín-Gamboa, M., Iribarren, D., Susmozas, A., Dufour, J. (2016) Delving into sensible measures to enhance the environmental performance of biohydrogen: A quantitative approach based on process simulation, life cycle assessment and data envelopment analysis. *Bioresource Technology*, **214**, 376–385.
  - Mehmeti, A., Angelis-Dimakis, A., Arampatzis, G., McPhail, S.J., Ulgiati, S. (2018) Life cycle assessment and water footprint of hydrogen production methods: From conventional to emerging technologies. *Environments - MDPI*, **5**, 1–19.
  - *Hydrogen from biomass: state of the art and research challenges* (2002, Golden, CO). 2002. Ed. Milne, T.A., Elam, C.C., Evans, R.J. Golden, CO,
  - Moreno, J., Dufour, J. (2013) Life cycle assessment of hydrogen production from biomass gasification. Evaluation of different Spanish feedstocks. *International Journal of Hydrogen Energy*, **38**, 7616–7622.
  - Muresan, M., Cormos, C.C., Agachi, P.S. (2014) Comparative life cycle analysis for

gasification-based hydrogen production systems. *Journal of Renewable and Sustainable Energy*, **6**, .

- Nikolaidis, P., Poullikkas, A. (2017) A comparative overview of hydrogen production processes. *Renewable and Sustainable Energy Reviews*, **67**, 597–611.
- *JEC Well-to-Tank report v5 | EUR 30269 EN | JRC119036* (2020, Luxembourg). 2020. Ed. Prussi, M., Yugo, M., De Prada, L., Padella, M., Edwards, R., Lonza, L. Luxembourg,
- Reaño, R.L. (2020) Assessment of environmental impact and energy performance of rice husk utilization in various biohydrogen production pathways. *Bioresource Technology*, **299**, 122590.
- Simons, A., Bauer, C. (2011) Life cycle assessment of hydrogen production In *Transition to Hydrogen: Pathways Toward Clean Transportation* s.l.: Cambridge University Press: pp. 13–57.
- Singh, L., Wahid, Z.A. (2015) Methods for enhancing bio-hydrogen production from biological process: A review. *Journal of Industrial and Engineering Chemistry*, **21**, 70–80.
- Valente, A., Iribarren, D., Dufour, J. (2017) Harmonised life-cycle global warming impact of renewable hydrogen. *Journal of Cleaner Production*, **149**, 762–772.
- \_\_\_\_\_. (2018) Harmonising the cumulative energy demand of renewable hydrogen for robust comparative life-cycle studies. *Journal of Cleaner Production*, **175**, 384–393.
- *Global Bioenergy Statistics 2020* (2020, s.l.). 2020. Ed. World Bioenergy Association. s.l.,

## Appendix P6: Hydrogen Production Pathway – Auto thermal Reforming with Carbon Capture and Storage

### P6.1. ATR/CCS Process Description

An auto-thermal reformer is typically considered ‘self-heating’ as it includes the exothermic oxidation of methane which provides enough heat to support the concurrent endothermic reforming reaction.

In Auto Thermal Reforming (ATR)<sup>49</sup>, methane is first partially oxidized to produce hydrogen and carbon monoxide. Contrary to the steam methane reformer, the auto thermal reactor does not require any heat from an external source (although other external heating operations may still be required, such as pre-heaters). The partial oxidation reaction is exothermic and provides the required heat to the concurrent steam reforming reaction, taking place in the auto thermal reactor, in which methane and steam reacts to produce carbon monoxide and hydrogen in the reformer fixed catalyst bed. The syngas stream is then fed to the water-gas shift reactor(s) to further convert the carbon monoxide and excess steam into hydrogen and CO<sub>2</sub>.

Oxygen required for the partial oxidation reaction is separated from air in an air separation unit (ASU), typically cryogenically. The partial oxidation reaction occurs in the top section of the autothermal reformer. The top section is fitted with a burner where methane and oxygen are mixed in a diffusion flame.

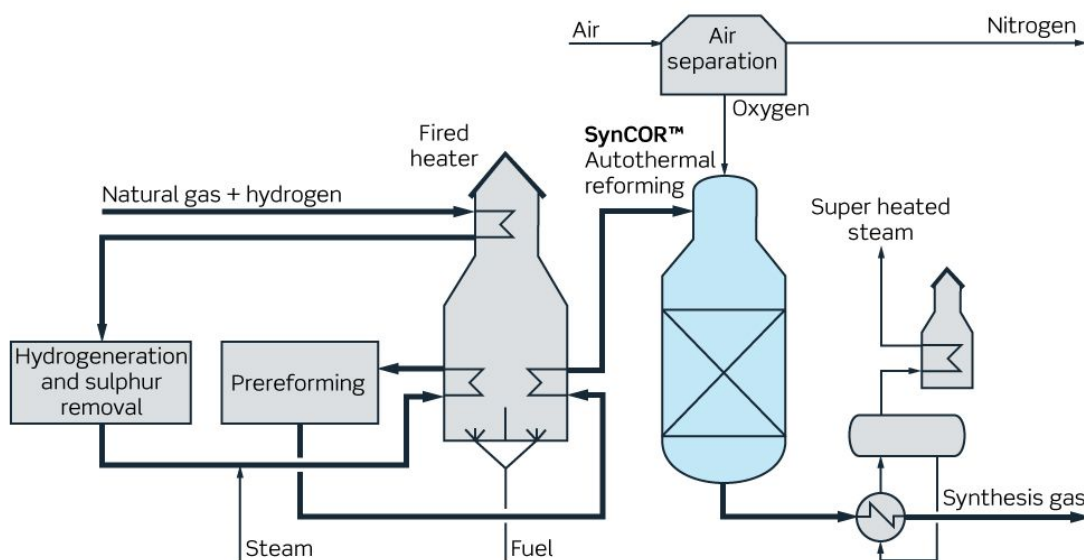

**Figure P6. 1: Diagram of a typical ATR configuration**

In practice, there are a number of configurations in which ATRs can be deployed, including in combinations with other reformers. These arrangements can help to optimize hydrogen yields

<sup>49</sup> <https://www.sciencedirect.com/science/article/pii/S0196890422000413#f0015>

while minimizing flue gas heat losses. Possible configurations include: using a fired tubular reformer in series with a heat exchange steam reformer (HSER), working as a gas-heated pre-reformer; using an HSER in series with an ATR to form a two-staged configuration; or deploying an ATR followed by a gas heated reformer, where the counter-current heat exchange with a product syngas from the ATR provides the heat for the endothermic reforming reaction.

Whereas steam methane reforming typically requires post-combustion CO<sub>2</sub> capture, in ATR CO<sub>2</sub> capture can typically be achieved entirely through process CO<sub>2</sub> capture from the hydrogen product stream. This is typically conducted before the hydrogen purification step, using chemical solvent absorption. The CO<sub>2</sub> can then be compressed and dehydrated for export.

## P6.2. ATR/CCS Overview

Depending on the available data of the natural gas used, the emission factor of the used gas (as energy or feedstock) (kgCO<sub>2e</sub> / MWh<sub>LHV</sub>) can be taken from (i) a well-documented emission factor of the gas purchased or if not available (ii) calculated by developing the upstream system as described in 6.3.3.4.3.

### Autothermal reforming system

The base case consists of: (a) feedstock pre-treatment (heating and pressurization), (b) prereformer (sulphur and mercury removal), (c) primary reformer (ATR), (d) shift reactors (high & low temperature) and (e) pressure swing absorption (PSA). The primary reformer is fed by an air separation unit.

For the ATR system, the co-products are carbon dioxide and, for some configurations, steam. Steam can be used to produce electricity, if there is associated power generation, e.g. combined heat-power or cogeneration applications.

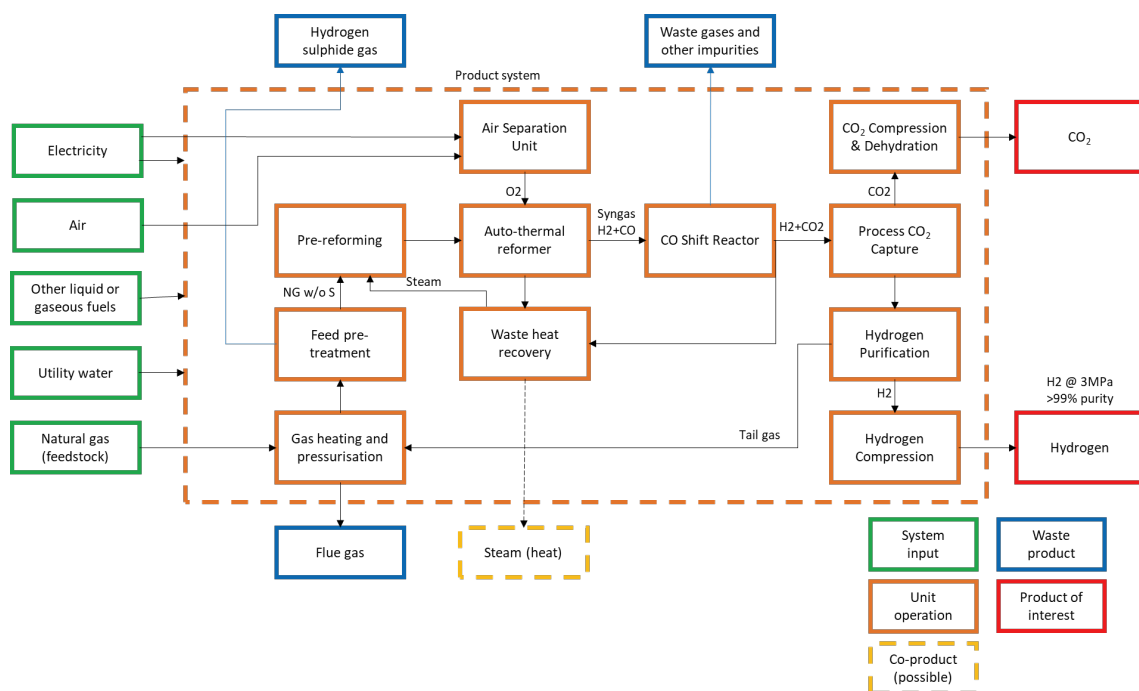

Figure P6. 2: Process diagram for hydrogen produced from ATR/CCS

### P6.3. Emissions Sources in ATR/CCS

For auto-thermal reforming with CCS, the main source of GHG emissions is the combustion of natural gas (NG). Other significant emissions sources include GHG leakages<sup>50</sup>, separation and capture of CO<sub>2</sub>, CO<sub>2</sub> compression and transport for CCS.

Each process unit or stage in the ATR process contains unique emissions sources as outlined in **Table P6. 1**.

**Table P6. 1: Key life cycle GHG emission sources in H<sub>2</sub> production by ATR**

Process unit/stage	Key emissions sources	Other emissions sources
Natural gas recovery	<ul style="list-style-type: none"> <li>• Electricity and/or fuel combustion for natural gas extraction and transportation to a processing plant</li> <li>• Fugitive methane and/or carbon dioxide from natural gas extraction and transport</li> </ul>	- Flaring and venting
Natural gas processing	<ul style="list-style-type: none"> <li>• Electricity and/or fuel combustion for separating heavier components of recovered gas (e.g., natural gas liquid) or acid gases (e.g., CO<sub>2</sub>) from pipeline-quality natural gas</li> <li>• Fugitive methane and/or carbon dioxide from natural gas processing</li> </ul>	
Gas transport	<ul style="list-style-type: none"> <li>• Electricity and/or fuel combustion for gas transportation</li> <li>• Fugitive methane emissions</li> </ul>	
Heat recovery and electricity generation	<ul style="list-style-type: none"> <li>• No significant emissions other than those covered under common emissions sources</li> </ul>	
Auxiliary Heating Processes	<ul style="list-style-type: none"> <li>• Electricity and/or fuel combustion to provide auxiliary heat, e.g. in pre-heaters</li> </ul>	
Air separation	<ul style="list-style-type: none"> <li>• Electricity and/or fuel combustion to separate oxygen from air to feed reformer</li> </ul>	
CO <sub>2</sub> and H <sub>2</sub> purification	<ul style="list-style-type: none"> <li>• Electricity and/or heat for operation of the relevant purification units</li> </ul>	Exhaust CO <sub>2</sub> due to sulphur removal of exhaust gases (where applicable)
Hydrogen enrichment	<ul style="list-style-type: none"> <li>• Electricity and/or heat to supply water gas shift reactions occurring as part of hydrogen enrichment (if required)</li> </ul>	
CO <sub>2</sub> capture and separation	<ul style="list-style-type: none"> <li>• Electricity and/or heat for relevant separation units</li> <li>• Residual CO<sub>2</sub> which is not captured for permanent storage</li> </ul>	
Compression and transportation of CO <sub>2</sub>	<ul style="list-style-type: none"> <li>• Electricity for compression of CO<sub>2</sub></li> <li>• Electricity and/or fuel combustion for pipeline transport</li> <li>• Fuel combustion for motive transport</li> <li>• Fugitive carbon dioxide emissions</li> </ul>	

<sup>50</sup> [https://publications.pik-potsdam.de/rest/items/item\\_26512\\_1/component/file\\_26534/content](https://publications.pik-potsdam.de/rest/items/item_26512_1/component/file_26534/content)

Storage of CO <sub>2</sub>	<ul style="list-style-type: none"> <li>Electricity/fuel use for compression and injection</li> </ul>	Fugitive CO <sub>2</sub> from permanent storage location <sup>51</sup>
Hydrogen compression and storage	<ul style="list-style-type: none"> <li>Electricity for compression and storage maintenance</li> </ul>	Fugitive hydrogen emissions <sup>52</sup>
Disposal of waste products (where not valorized)	<ul style="list-style-type: none"> <li>Electricity and fuel combustion for transportation of waste products</li> </ul>	

#### P6.4. Allocation for the ATR/CCS pathway

Several co-products may exist for an ATR/CCS system. Steam, a captured CO<sub>2</sub> stream and potentially electricity are introduced as examples, but exact coproducts are representative of specific designs.

If steam is exported from the system, subdivision by systems (cf. 6.3.3.4.2) is applied when feasible to calculate the associated GHG emissions.

If electricity is exported from the system, allocation by energy is applied to calculate the associated GHG emissions.

CO<sub>2</sub> capture and underground storage are considered as a CO<sub>2</sub> removal.

#### P6.5. Information to be reported for H<sub>2</sub> production by ATR<sup>53</sup>

Category	Matters to be identified
Facility details	<ul style="list-style-type: none"> <li>Facility identity</li> <li>Facility location</li> <li>Facility capacity (Nm<sup>3</sup>/h, t/h)</li> <li>Capacity Factor (%)</li> <li>Commencement of facility operation</li> <li>Main climatic and meteorological data (Atmospheric pressure, average ambient temperature, average relative humidity)</li> </ul>
Product specification	<ul style="list-style-type: none"> <li>Production pathway</li> <li>H<sub>2</sub> produced (kg)</li> <li>H<sub>2</sub> temperature and pressure at the gate</li> <li>H<sub>2</sub> purity level at the gate</li> <li>Specification of contaminants</li> </ul>
GHG emissions overview	<ul style="list-style-type: none"> <li>Emissions intensity of hydrogen batch [kgCO<sub>2</sub>e/kgH<sub>2</sub>]</li> <li>Type of offsets used (if applicable, noting that at this stage permitting the use of offsets is contentious and not recommended)</li> <li>Quantity of offsets used (if applicable, noting that at this stage permitting the use of offsets is contentious and not recommended)</li> </ul>

<sup>51</sup> These are not accounted for as part of the standard emissions calculation.

<sup>52</sup> The impacts of hydrogen as an indirect GHG have not been considered as part of emissions calculation given current focus on (direct) GHG emissions accounting.

<sup>53</sup> In a country where GO system and residual mix system are not used for electricity emission counting, reporting of GO and residual mix related matters cannot be necessary.

Batch details	<ul style="list-style-type: none"> <li>• Beginning and end of batch dates</li> <li>• Batch quantity</li> </ul>
Electricity	<p>Location-based emissions accounting:</p> <ul style="list-style-type: none"> <li>• Quantity of purchased grid electricity [kWh]</li> <li>• Location based emission factor used [kgCO<sub>2</sub>e/kWh]</li> </ul> <p>Market-based emissions accounting</p> <ul style="list-style-type: none"> <li>• Quantity of purchased grid electricity [kWh]</li> <li>• Quantity of contracted renewable electricity [kWh] and quantity of associated GOs or RECs</li> <li>• Type of GOs or RECs</li> <li>• Residual electricity</li> <li>• Residual mix emission factor [kgCO<sub>2</sub>e/kWh]</li> </ul> <p>On-site electricity generation</p> <ul style="list-style-type: none"> <li>• Quantity of on-site generation [kWh]</li> <li>• Emission factor for on-site generation (as applicable) [kgCO<sub>2</sub>e/kWh]</li> </ul>
Other utilities	<ul style="list-style-type: none"> <li>• Source/s of water</li> <li>• Source/s of steam</li> <li>• Quantity of purchased water [kg]</li> <li>• Quantity of purchased steam [kg]</li> <li>• Embodied emission factor for water [kgCO<sub>2</sub>e/kg]</li> <li>• Embodied emission factor for steam [kgCO<sub>2</sub>e/kg]</li> </ul>
Fuel feedstock	<ul style="list-style-type: none"> <li>• Types of fuels combusted</li> <li>• Quantities of fuel combusted [L, kg]</li> <li>• Relevant emissions calculation or factors used to attribute emissions to fuel combusted [kgCO<sub>2</sub>e/appropriate unit of fuel]</li> <li>• Emissions intensity of fuel used, including all emissions associated with fuel extraction, transporting to a processing plant, and processing [e.g. kgCO<sub>2</sub>e/mmbtu]</li> <li>• Credits claimed to evaluate emissions of fuel reformed</li> </ul>
Process	<ul style="list-style-type: none"> <li>• Air separation technology and capacity</li> <li>• ATR reactor type and capacity</li> <li>• Syngas purification technology and capacity</li> <li>• Sulphur waste gas processing technology (if applicable) and capacity</li> <li>• Quantity and type of vented GHG gases [kg]</li> <li>• Quantity and type of flared GHG gases [kg]</li> <li>• Technology for monitoring fugitives from CO<sub>2</sub> storage and capacity</li> <li>• CO<sub>2</sub> capture rate of the unit [%]</li> <li>• CO<sub>2</sub> capture technology</li> </ul>
Air separation	<ul style="list-style-type: none"> <li>• Electricity/fuel consumption [MJ, MWh]</li> </ul>
Cooling	<ul style="list-style-type: none"> <li>• Electricity consumption [MJ, MWh]</li> </ul>
Compression of gases throughout the facility	<ul style="list-style-type: none"> <li>• Electricity consumption [MJ, MWh]</li> </ul>
Natural Gas feedstock	<ul style="list-style-type: none"> <li>• Type of NG</li> <li>• NG composition</li> <li>• Quantity of NG used for ATR reactions [kg]</li> <li>• Quantity of NG used for heating [kg]</li> <li>• Quantity of NG used for producing steam [kg]</li> <li>• Embodied emission factor for NG [kgCO<sub>2</sub>e/kg] (derived from primary and secondary data, provided by supplier or sourced from relevant source i.e. NGA Factors)</li> </ul>
Carbon dioxide treatment	<ul style="list-style-type: none"> <li>• Type of CO<sub>2</sub> storage and capacity</li> <li>• Location of CO<sub>2</sub> storage</li> </ul>



	<ul style="list-style-type: none"> <li>• Transport type of CO<sub>2</sub> to storage location (if applicable) and distance (in km)</li> <li>• Quantity of CO<sub>2</sub> captured [kg]</li> <li>• Quantity of CO<sub>2</sub> stored [kg]</li> <li>• Quantity of fugitive emissions created during injection of CO<sub>2</sub> into the storage location [kg]</li> <li>• Quantity of fugitive CO<sub>2</sub> emissions from storage [kg] (in line with period covered by the reporting)</li> </ul>
Waste and other Co-products	<ul style="list-style-type: none"> <li>• Quantity of steam produced [kg]</li> <li>• Quantity of steam sold [kg]</li> <li>• Emissions allocated to steam [kgCO<sub>2</sub>e/kg]</li> <li>• Quantity of electricity sold (MWh)</li> <li>• Emissions allocated to electricity sold [kgCO<sub>2</sub>e/kWh]</li> </ul>

## Appendix C1: Ammonia as a Hydrogen Carrier

### C1.1. Ammonia Process Description

Worldwide, ammonia (NH<sub>3</sub>) is currently used primarily as a fertilizer or feedstock for chemical production and is of growing interest as a carrier of hydrogen and fuel. Advantages of ammonia as a hydrogen carrier include its volumetric hydrogen density (99 kgH<sub>2</sub>/m<sup>3</sup> in liquid form, at room temperature and 10 bar),<sup>54,55</sup> which is greater than liquid hydrogen, and that it liquefies at room temperature at modest pressure (~10 bar).<sup>56</sup> High density is desirable among hydrogen carriers to reduce the space requirements for delivery vessels and potentially reduce cost. Additionally, a high boiling point reduces the potential for boil-off losses that otherwise increase the delivery cost. Ammonia is typically produced via the Haber Bosch process, combining nitrogen and hydrogen over catalyst beds at elevated temperature and pressure. The hydrogen can be supplied via independent hydrogen production facilities (e.g., electrolyzers, industrial by-product streams, etc.) or produced by reforming or cracking natural gas or biogas, or by hydrocarbon gasification pathways that are closely integrated with the Haber Bosch process.

About 70% of ammonia production today relies on natural gas feedstock as the hydrogen supply source, and approximately 20% relies on coal.<sup>57</sup> Biogas could supplant conventional natural gas in ammonia production in pathways very similar to those that depend on conventional natural gas. Low-carbon pathways to ammonia production may include carbon capture and sequestration in conjunction with carbon-based feedstock and pathways that use clean hydrogen produced at independent facilities. Recommended life cycle analysis methods of these pathways are described in Sections C1.2 - C1.6 below.

Many other pathways to low-carbon ammonia production are currently in the R&D stages. Other pathways include the reduction of nitrogen to ammonia through electrochemical reactions in the presence of water, biological pathways, chemical looping pathways that produce ammonia as a byproduct, and the use of solid oxide electrolyzers to produce both hydrogen and nitrogen for ammonia synthesis.<sup>58</sup> Given the nascence of these pathways, they are not included in the current guidance.

### C1.2. System boundary

Today, about 90% of ammonia worldwide is used as a fertilizer, and the balance is mainly used in industrial applications, such as chemical production. There is growing interest in using ammonia as a fuel and a hydrogen carrier that is ultimately cracked to release pure hydrogen. The key sources of emissions in ammonia – the production, delivery, and cracking – can be categorized into modules, described in **Figure C1. 1** below. While the current document

---

<sup>54</sup> <https://www.frontiersin.org/articles/10.3389/fenrg.2021.580808/full>

<sup>55</sup> <https://pubs.acs.org/doi/10.1021/acseenergylett.1c02189>

<sup>56</sup> [https://www.cell.com/joule/pdf/S2542-4351\(20\)30173-2.pdf](https://www.cell.com/joule/pdf/S2542-4351(20)30173-2.pdf)

<sup>57</sup> <https://pubs.rsc.org/en/content/articlelanding/2020/gc/d0gc02301a>

<sup>58</sup> <https://royalsociety.org/-/media/policy/projects/green-ammonia/green-ammonia-policy-briefing.pdf>

focuses on the emissions associated with ammonia as a hydrogen carrier, emissions associated with ammonia production for other uses may also be calculated using Modules 1-3 of the current methodology.

The configurations of ammonia production plants vary widely, and hydrogen production can be closely integrated with ammonia production. The guidance below in Sections C1.3 - C1.4 below describes the mechanism to characterize the combined emissions of Modules 1 and 3 when these steps are integrated. If hydrogen is produced independent of the ammonia production process, the emissions associated with Module 1 should be calculated per the IPHE’s “Methodology for determining the greenhouse gas emissions associated with the production of hydrogen.” Section C1.5 below describes the mechanism to characterize emissions associated with Module 3 in a scenario where hydrogen production is independent. Analysis methods to characterize Module 2 will be developed in future guidance. All modules must be accounted for to depict the total life cycle emissions of ammonia used as a hydrogen carrier. As noted previously, the reporting metric corresponding to an analysis of Modules 1-5 is kgCO<sub>2</sub>e/kgH<sub>2</sub>.

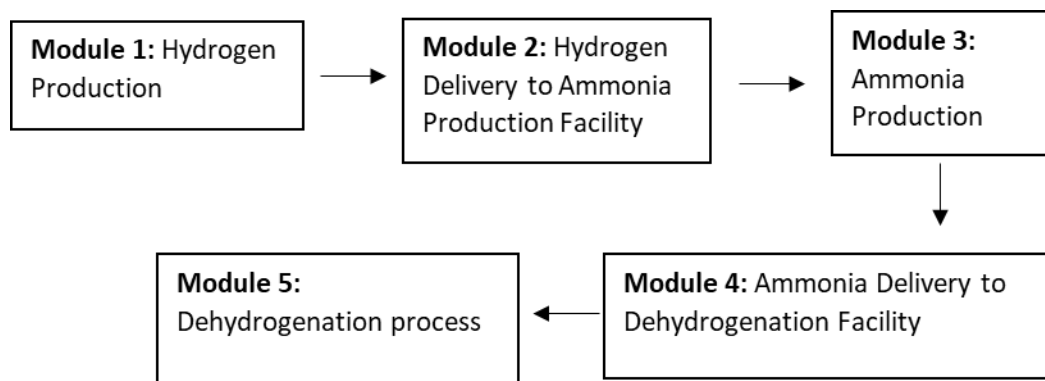

**Figure C1. 1: Modules for Life Cycle Analysis of Ammonia**

In scenarios where ammonia is produced for direct use (e.g. as a fertilizer or fuel) rather than use as a carrier, the life cycle emissions of ammonia production could be depicted as kg CO<sub>2</sub>e/kg NH<sub>3</sub> through analysis of Modules 1, 2, and 3.

### **C1.3. Ammonia Production from Natural Gas or Biogas with Carbon Capture and Sequestration**

Ammonia production from natural gas typically includes the use of reformers that are additionally supplied with high-temperature steam (up to 1,000°C) and ambient air to generate syngas that comprises hydrogen, nitrogen, carbon monoxide (CO), carbon dioxide (CO<sub>2</sub>), methane, and residual steam. This syngas is then passed through a water gas shift (WGS) reactor wherein the CO and steam are used to generate additional hydrogen and CO<sub>2</sub>. The carbon dioxide is subsequently removed from the outlet of the WGS reactor and may be sequestered.<sup>59</sup> The rest of the syngas is passed through a unit that converts the remaining CO

<sup>59</sup> The CO<sub>2</sub> may also be captured and utilized in other industrial processes. However, scenarios where CO<sub>2</sub> is utilized are not within the scope of the current guidance.

to methane to prevent Haber Bosch catalysts' poisoning. This methane can ultimately be passed back through the reformers to generate more hydrogen supply.<sup>54-60</sup> Configurations of ammonia production plants vary worldwide, but an example process diagram of a facility using natural gas is depicted in **Figure C1. 2**. Upstream emissions associated with ammonia production are described in **Figure C1. 3**. This pathway can also be utilized to produce hydrogen from biogas.

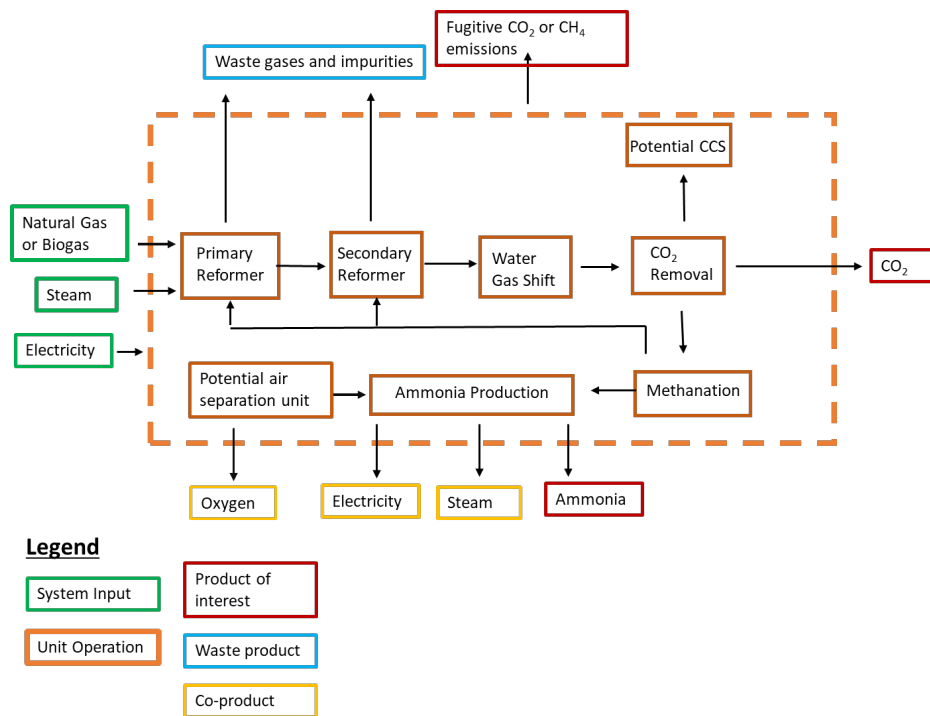

**Figure C1. 2: Example configuration of natural gas-based ammonia production facility.**

Compressors are not depicted in this figure but are incorporated throughout ammonia production plants. Key attributes of real-world facilities that will commonly vary include the design of the reformer, potential use of refrigeration equipment to separate purge gases, and potential combustion of additional fuels onsite for heat and power generation.

<sup>60</sup> <https://www.aiche.org/resources/publications/cep/2016/september/introduction-ammonia-production>

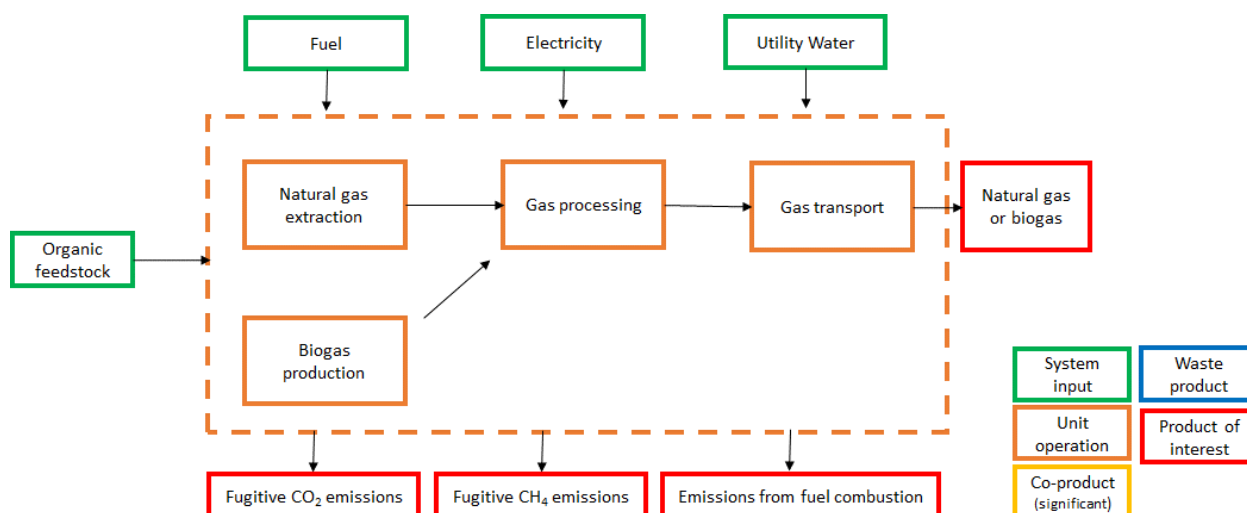

**Figure C1. 3: Upstream emissions associated with ammonia production.**

Emissions related to biogas production should be accounted for consistently with the IPHE Biomass Working Group Guidance.

Carbon capture and sequestration (CCS) facilities can be deployed with conventional ammonia production plants to minimize carbon emissions. Emissions that should be accounted for in the life cycle analysis of ammonia production from natural gas or biogas with CCS are described in **Table C1. 1**.

**Table C1. 1: Key Life Cycle GHG Emission Sources in Ammonia Production from Natural Gas or Biogas with CCS**

Process unit/stage	Key emissions sources	Secondary emissions sources
Natural gas recovery	<ul style="list-style-type: none"> <li>Electricity and/or fuel combustion for natural gas extraction and transportation to a processing plant</li> <li>Fugitive methane and/or carbon dioxide from natural gas extraction</li> </ul>	
Natural gas processing	<ul style="list-style-type: none"> <li>Electricity and/or fuel combustion for separating heavier components of recovered gas (e.g., natural gas liquid) or acid gases (e.g., CO<sub>2</sub>) from pipeline-quality natural gas</li> <li>Fugitive methane and/or carbon dioxide from natural gas processing</li> </ul>	
Production of biogas and processing <sup>61</sup>	<ul style="list-style-type: none"> <li>Electricity/fuel consumption for biogas production and purification</li> <li>Fugitive methane and/or carbon dioxide emissions during production</li> <li>Electricity/energy consumption in the gas cleanup</li> <li>Avoided methane and/or carbon dioxide emissions due to biogas production (credit)</li> </ul>	

<sup>61</sup> Emissions associated with the production of biogas should be calculated in a manner consistent with the guidance in the IPHE H2PA biomass-based hydrogen production pathway.

Gas transport	<ul style="list-style-type: none"> <li>• Electricity and/or fuel combustion for gas transportation</li> <li>• Fugitive methane emissions</li> </ul>	
Steam generation	<ul style="list-style-type: none"> <li>• Combustion of fossil fuels or electricity consumption for generation (onsite or by a third party)</li> </ul>	
Ammonia Production	<ul style="list-style-type: none"> <li>• Electricity and fuel for ammonia production</li> <li>• Carbon dioxide released from a stack</li> <li>• Fugitive methane or CO<sub>2</sub> emissions (not reused within ammonia plant)</li> </ul>	
CO <sub>2</sub> capture	<ul style="list-style-type: none"> <li>• Electricity and/or heat used in CO<sub>2</sub> capture units</li> <li>• Residual CO<sub>2</sub> which is not captured for permanent storage</li> </ul>	
Compression for transportation of CO <sub>2</sub>	<ul style="list-style-type: none"> <li>• Electricity for compression of CO<sub>2</sub></li> <li>• Electricity and/or fuel combustion for pipeline transport of CO<sub>2</sub></li> <li>• Fuel combustion for motive transport of CO<sub>2</sub></li> <li>• Fugitive CO<sub>2</sub> emissions</li> </ul>	
Storage of CO <sub>2</sub>	<ul style="list-style-type: none"> <li>• Electricity/fuel use for compression and injection of CO<sub>2</sub></li> </ul>	Fugitive CO <sub>2</sub> emissions from a permanent storage location

As mentioned above, the configuration of ammonia plants can vary widely. Depending on how a plant is configured and the equipment it includes, the process could generate co-products; **Table C1. 2** describes potential co-products from ammonia production via natural gas or biogas with CCS, as well as a recommended approach to attribute emissions to those co-products if they are valorized.

**Table C1. 2: Potential Co-Products and Emissions Accounting Framework for Ammonia Production from Natural Gas or Biogas**

Step	Potential Co-Products	Recommended Approach to Emissions Accounting
Ammonia production	Steam	Subdivision by systems (when feasible)
Ammonia production	Electricity	Subdivision by systems (when feasible)

**Table C1. 3** describes reporting requirements for ammonia producers to demonstrate their alignment with the current IPHE guidance.

**Table C1. 3 Information to be reported for Reforming Pathway to Ammonia Production**

Category	Parameters to Report
Facility details	<ul style="list-style-type: none"> <li>• Facility identity</li> <li>• Facility location</li> <li>• Facility capacity</li> <li>• Commencement of facility operation</li> </ul>
Product specification	<ul style="list-style-type: none"> <li>• Ammonia produced (kg)</li> <li>• Ammonia temperature and pressure at the gate</li> <li>• Ammonia purity level at the gate</li> <li>• Specification of contaminants</li> </ul>

GHG emissions overview	<ul style="list-style-type: none"> <li>Emissions intensity of ammonia production process (kgCO<sub>2</sub>e/kgNH<sub>3</sub> produced)</li> </ul>
Batch details	<ul style="list-style-type: none"> <li>Beginning and end of batch dates</li> <li>Batch quantity [kg]</li> </ul>
Electricity	<p>Location-based emissions accounting:</p> <ul style="list-style-type: none"> <li>Quantity of purchased grid electricity [kWh]</li> <li>Location based emission factor used [kgCO<sub>2</sub>e/kWh]</li> </ul> <p>Market-based emissions accounting</p> <ul style="list-style-type: none"> <li>Quantity of purchased grid electricity [kWh]</li> <li>Quantity of contracted renewable electricity [kWh] and/or quantity of associated GOs or RECs</li> <li>Type of GOs or RECs</li> <li>Residual electricity</li> <li>Residual mix emission factor [kgCO<sub>2</sub>e/kWh]</li> </ul> <p>On-site electricity generation</p> <ul style="list-style-type: none"> <li>Quantity of on-site generation [kWh]</li> <li>Emission factor for on-site generation (as applicable) [kgCO<sub>2</sub>e/kWh]</li> </ul>
Feedstock	<ul style="list-style-type: none"> <li>Types of fuels reformed (e.g., natural gas, biogas)</li> <li>Quantities of fuel reformed (L, kg)</li> <li>Relevant emissions calculations or factors used to attribute emissions to fuel combusted (kgCO<sub>2</sub>e/appropriate unit of fuel)</li> <li>Emissions intensity of fuel used, including all emissions associated with fuel extraction, transporting to a processing plant, and processing [e.g. kgCO<sub>2</sub>e/mmbtu]</li> <li>Credits claimed to evaluate emissions of fuel reformed</li> </ul>
Natural Gas feedstock	<ul style="list-style-type: none"> <li>Type of NG</li> <li>NG composition</li> <li>Quantity of NG used for ATR reactions [kg]</li> <li>Quantity of NG used for heating [kg]</li> <li>Quantity of NG used for producing steam [kg]</li> <li>Embodied emission factor for NG [kgCO<sub>2</sub>e/kg] (derived from primary and secondary data, provided by supplier or sourced from relevant source i.e. NGA Factors)</li> </ul>
Carbon dioxide treatment	<ul style="list-style-type: none"> <li>Type of CO<sub>2</sub> storage and capacity</li> <li>Location of CO<sub>2</sub> storage</li> <li>Transport type of CO<sub>2</sub> to storage location (if applicable) and distance (in km)</li> <li>Quantity of CO<sub>2</sub> captured [kg]</li> <li>Quantity of CO<sub>2</sub> stored [kg]</li> <li>Quantity of fugitive emissions created during injection of CO<sub>2</sub> into the storage location [kg]</li> <li>Quantity of fugitive CO<sub>2</sub> emissions from storage [kg] (in line with period covered by the reporting)</li> </ul>
Waste and other Co-products	<ul style="list-style-type: none"> <li>Quantity of steam produced [kg]</li> <li>Quantity of steam sold [kg]</li> <li>Emissions allocated to steam [kgCO<sub>2</sub>e]</li> <li>Quantity of electricity sold [MWh]</li> <li>Emissions allocated to electricity sold [kgCO<sub>2</sub>e]</li> </ul>

### C1.4. Ammonia Production from Gasification of Fossil Fuels, Waste, or Solid Biomass with Carbon Capture and Sequestration

Gasification pathways can use fossil, waste, and bio feedstocks (e.g., coal, petroleum coke, municipal solid waste, or solid biomass) to produce hydrogen and then use air separation units to produce oxygen for the gasifier and nitrogen for the ammonia production. The gasifier generates syngas, reformers, and water-gas-shift reactors are used to produce hydrogen, acid gas removal equipment and cooling are used to remove impurities (e.g., solid sulfur) and purge gases, methanation equipment is used to produce methane from residual CO within the syngas, and catalyst beds are used to produce ammonia via the Haber Bosch process. Steam supplied to gasifiers is commonly made by leveraging waste heat within the facility but may also be produced using boilers.<sup>62</sup>

Gasification plants that produce ammonia can have several different configurations. One configuration example is depicted in **Figure C1. 4**. This pathway generates many additional products (such as steam, ash, and sulfur) that could be valorized, vented, or disposed of through traditional means (e.g., landfills). As in the other pathways described, if these products are valorized, they may be allocated emissions per the co-product accounting methodology described in **Table C1. 3**.

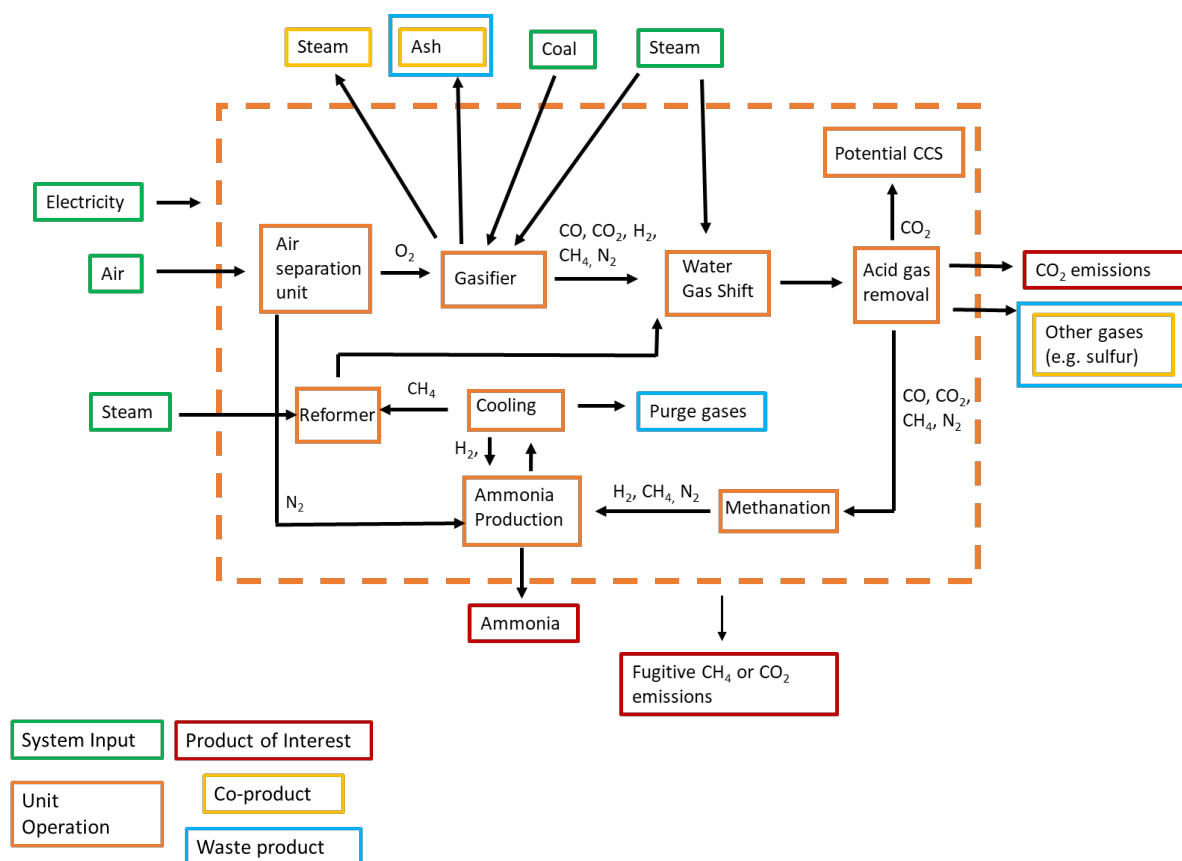

**Figure C1. 4: Example configuration of an ammonia production plant using gasifiers.<sup>63</sup>**

<sup>62</sup> <https://www.sciencedirect.com/science/article/abs/pii/S0263876215002130>

<sup>63</sup> Adapted from <https://www.sciencedirect.com/science/article/abs/pii/S0263876215002130>



Compressors are not depicted in this figure but are typically incorporated throughout the plant. Key attributes of real-world facilities that will commonly vary include whether a reformer is included, recycling of the ammonia feed, the design of the reformer (if included), gas cleanup performed (e.g., CO and acid gas removal), and whether the reformers use heat from the gasifiers or require additional fuel<sup>60</sup>. Products shown with both blue and yellow borders may be co-products or waste products, depending on whether they are valorized.

Pathways based on gasification can also be supplemented with CCS. Emissions associated with this pathway are described in **Table C1. 4** below.

**Table C1. 4 Key Emissions from Ammonia Production from Gasifiers with CCS**

Process unit/stage	Key emissions sources	Secondary emissions sources
Production of fossil, waste, or biomass feedstock <sup>61</sup>	<ul style="list-style-type: none"> <li>Electricity and/or liquid fuel combustion for raw materials extraction (e.g., coal)</li> <li>Fugitive methane and/or carbon dioxide from coal extraction</li> <li>Avoided methane and/or carbon dioxide emissions due to the use of biomass or waste (credit)</li> </ul>	Explosives for coal extraction
Feedstock processing	<ul style="list-style-type: none"> <li>Electricity/fuel use for loading and unloading of feedstock and processing (e.g., size reduction, washing, separation, and drying)</li> </ul>	Chemical usage for coal processing
Feedstock transport	<ul style="list-style-type: none"> <li>Electricity and/or fuel combustion for feedstock transportation</li> </ul>	
Air separation	<ul style="list-style-type: none"> <li>Electricity/fuel consumption</li> </ul>	
Gasification	<ul style="list-style-type: none"> <li>Combustion and gasification</li> <li>Carbon dioxide released from the stack</li> <li>Fugitive methane or carbon dioxide emissions (not reused within ammonia plant)</li> </ul>	
Steam generation	<ul style="list-style-type: none"> <li>Combustion of fossil fuels or electricity consumption for generation (onsite or by a third party)</li> </ul>	
Cooling	<ul style="list-style-type: none"> <li>Electricity consumption</li> </ul>	
Compression of gases throughout the facility	<ul style="list-style-type: none"> <li>Electricity consumption</li> </ul>	
CO <sub>2</sub> capture	<ul style="list-style-type: none"> <li>Electricity and/or heat used in CO<sub>2</sub> capture units</li> <li>Residual CO<sub>2</sub> which is not captured for permanent storage</li> </ul>	
Compression for transportation of CO <sub>2</sub>	<ul style="list-style-type: none"> <li>Electricity for compression of CO<sub>2</sub></li> <li>Electricity and/or gaseous fuel combustion for pipeline transport</li> <li>Fuel combustion for motive transport</li> <li>Fugitive CO<sub>2</sub> emissions</li> </ul>	
Storage of CO <sub>2</sub>	<ul style="list-style-type: none"> <li>Electricity/fuel use for storage compression and injection or transformation</li> </ul>	Fugitive CO <sub>2</sub> emissions from the permanent storage location

Disposal of waste products (where not valorized)	<ul style="list-style-type: none"> <li>Electricity and fuel combustion for transportation of waste products</li> </ul>	
--	--	--

**Table C1. 5** describes potential co-products from gasification with CCS and recommends attributing emissions to those co-products.

The co-products can only be attributed to emissions if they are valorized.

**Table C1. 5: Potential Co-Products and Emissions Accounting Frameworks for Ammonia Production from Gasifiers with CCS**

Step	Potential Co-Product (if valorized)	Recommended Approach to Emissions Accounting
Steam generation	Steam	Subdivision by systems (when feasible)
Gasification	Steam	Subdivision by systems (when feasible)
Gasification	Ash	System expansion
Acid gas removal	Impurities, such as sulfur	Mass-based
Gasification	Electricity	Subdivision by systems (when feasible)

**Table C1. 6** describes reporting requirements for ammonia producers utilizing gasification pathways to demonstrate alignment with the current IPHE guidance.

**Table C1. 6 Information to be reported for Gasification Based Ammonia Production Pathway**

Category	Parameters to Report
Facility details	<ul style="list-style-type: none"> <li>Facility identity</li> <li>Facility location</li> <li>Facility capacity</li> <li>Commencement of facility operation</li> </ul>
Product specification	<ul style="list-style-type: none"> <li>Ammonia produced (kg)</li> <li>Ammonia temperature and pressure at gate</li> <li>Ammonia purity level at the gate [%]</li> <li>Specification of contaminants</li> </ul>
GHG emissions overview	<ul style="list-style-type: none"> <li>Emissions intensity of ammonia production process (kgCO<sub>2</sub>e/kgNH<sub>3</sub> produced)</li> </ul>
Batch details	<ul style="list-style-type: none"> <li>Beginning and end of batch dates</li> <li>Batch quantity</li> </ul>
Electricity	Location-based emissions accounting: <ul style="list-style-type: none"> <li>Quantity of purchased grid electricity [kWh]</li> <li>Location based emission factor used [kgCO<sub>2</sub>e/kWh]</li> </ul> Market-based emissions accounting <ul style="list-style-type: none"> <li>Quantity of purchased grid electricity [kWh]</li> <li>Quantity of contracted renewable electricity [kWh] and/or quantity of associated GOs or RECs</li> <li>Type of GOs or RECs</li> <li>Residual electricity</li> <li>Residual mix emission factor [kgCO<sub>2</sub>e/kWh]</li> </ul> On-site electricity generation <ul style="list-style-type: none"> <li>Quantity of on-site generation [kWh]</li> </ul>

	<ul style="list-style-type: none"> <li>Emission factor for on-site generation (as applicable) [kgCO<sub>2</sub>e/kWh]</li> </ul>
Feedstock <sup>61</sup>	<ul style="list-style-type: none"> <li>Types of fuels combusted</li> <li>Quantities of fuel combusted (L, kg)</li> <li>Relevant emissions calculations or factors used to attribute emissions to fuel combusted (kgCO<sub>2</sub>e/appropriate unit of fuel)</li> <li>Emissions intensity of fuel used, including all emissions associated with fuel extraction, transporting to a processing plant, and processing [e.g. kgCO<sub>2</sub>e/mmbtu]</li> <li>Credits claimed to evaluate emissions of fuel combusted</li> </ul>
Waste and other Co-products	<ul style="list-style-type: none"> <li>Quantity of steam produced [kg]</li> <li>Quantity of steam sold [kg]</li> <li>Emissions allocated to steam [kgCO<sub>2</sub>e]</li> <li>Quantity of ash produced [kg]</li> <li>Quantity of ash sold [kg]</li> <li>Emissions allocated to ash [kgCO<sub>2</sub>e]</li> <li>Quantity of other gases (e.g., sulfur) produced [kg]</li> <li>Quantity of other gases sold [kg]</li> <li>Emissions allocated to other gases [kgCO<sub>2</sub>e]</li> </ul>

### C1.5. Ammonia Production from Hydrogen and Nitrogen

Other pathways to produce ammonia include using independently produced, low-carbon hydrogen that is either produced onsite or delivered. If the hydrogen is delivered, high-throughput delivery pathways, such as pipelines or transport in liquid form (e.g., in rail or marine vessels), are most likely given the significant quantity of hydrogen required at commercial ammonia plants. An example configuration of this pathway is depicted in **Figure C1. 5**.

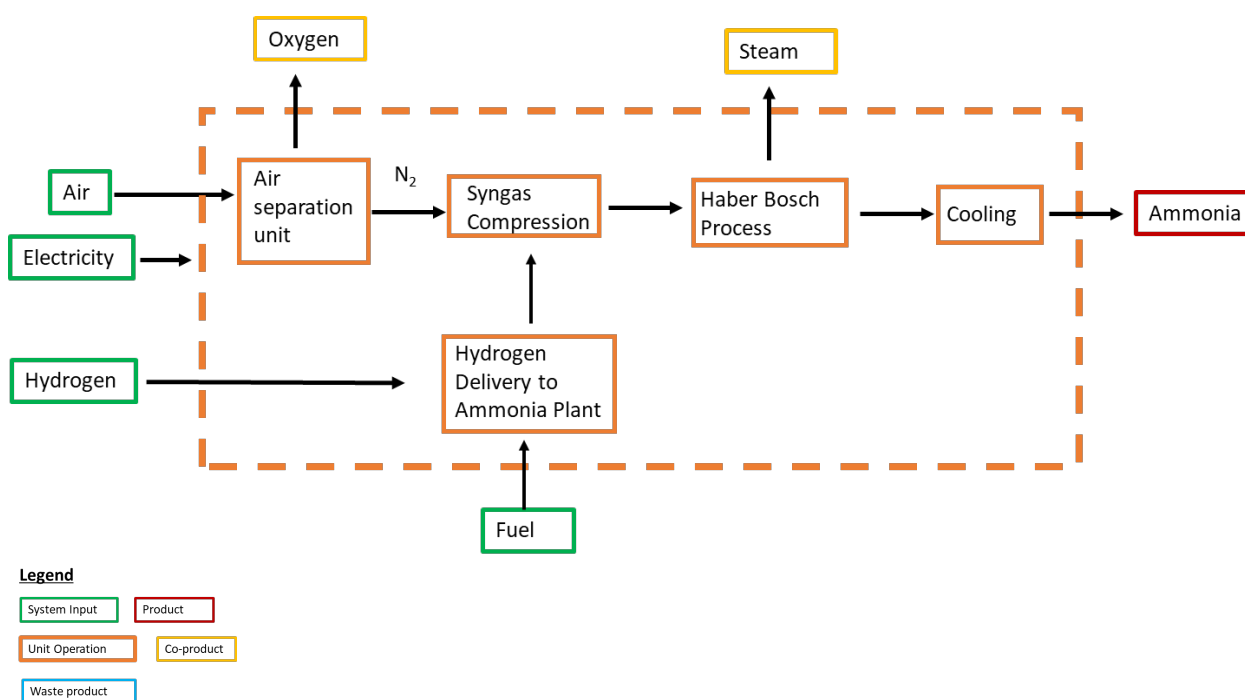

**Figure C1. 5: Ammonia Production from Hydrogen Adapted from Liu et al.<sup>4</sup>**

Key drivers of GHG emissions in ammonia production using clean hydrogen feedstock are described in **Table C1. 7**. Potential co-products are described in **Table C1. 8**.

**Table C1. 7: Key Emissions from Ammonia Production from Clean Hydrogen**

Process unit/stage	Key emissions sources	Secondary Emission Sources
Low-carbon hydrogen production	<ul style="list-style-type: none"> <li>Emissions will be dependent on the production pathway and should be calculated via IPHE H2PA guidance</li> </ul>	
Hydrogen delivery	<ul style="list-style-type: none"> <li>Electricity/fuel consumption for hydrogen compression in pipelines</li> <li>Electricity consumption for hydrogen liquefaction upstream of the ammonia plant</li> <li>Fuel combustion for liquid hydrogen transport to the ammonia plant (e.g., via rail or barges)</li> </ul>	
Air separation unit	<ul style="list-style-type: none"> <li>Electricity consumption</li> </ul>	
Compression of syngas, nitrogen, and/or hydrogen	<ul style="list-style-type: none"> <li>Electricity consumption</li> <li>Fugitive emissions</li> </ul>	
Haber-Bosch Process	<ul style="list-style-type: none"> <li>Electricity consumption</li> <li>Fugitive emissions</li> </ul>	
Cooling	<ul style="list-style-type: none"> <li>Electricity consumption</li> </ul>	

**Table C1. 8: Potential co-products and Emissions Accounting Framework for Ammonia Production from Clean Hydrogen**

Step	Potential co-product	Recommended approach to emissions accounting
Air separation unit	Oxygen	Use of allocation factors specified in the Ecoinvent database, as further described in the IPHE “Methodology for determining the greenhouse gas emissions associated with the production of hydrogen” <sup>64</sup>
Ammonia production	Steam	Subdivision by systems when feasible

**Table C1. 9** describes reporting requirements for ammonia producers to demonstrate alignment with the current IPHE guidance.

**Table C1. 9 Information to be reported for Ammonia Production**

Category	Parameters to Report
Facility details	<ul style="list-style-type: none"> <li>Facility identity</li> <li>Facility location</li> <li>Facility capacity</li> <li>Commencement of facility operation</li> </ul>
Product specification	<ul style="list-style-type: none"> <li>Ammonia produced (kg)</li> <li>Ammonia temperature and pressure at gate</li> </ul>

<sup>64</sup> [https://db.ecoinvent.org/reports/08\\_Chemicals.pdf](https://db.ecoinvent.org/reports/08_Chemicals.pdf)

	<ul style="list-style-type: none"> <li>• Ammonia purity level at the gate [%]</li> <li>• Specification of contaminants</li> </ul>
GHG emissions overview	<ul style="list-style-type: none"> <li>• Emissions intensity of ammonia production process (kgCO<sub>2</sub>e/kgNH<sub>3</sub> produced)</li> </ul>
Batch details	<ul style="list-style-type: none"> <li>• Beginning and end of batch dates</li> <li>• Batch quantity</li> </ul>
Electricity	<p>Location-based emissions accounting:</p> <ul style="list-style-type: none"> <li>• Quantity of purchased grid electricity [kWh]</li> <li>• Location based emission factor used [kgCO<sub>2</sub>e/kWh]</li> </ul> <p>Market-based emissions accounting</p> <ul style="list-style-type: none"> <li>• Quantity of purchased grid electricity [kWh]</li> <li>• Quantity of contracted renewable electricity [kWh] and/or quantity of associated GOs or RECs</li> <li>• Type of Gos or RECs</li> <li>• Residual electricity</li> <li>• Residual mix emission factor [kgCO<sub>2</sub>e/kWh]</li> </ul> <p>On-site electricity generation</p> <ul style="list-style-type: none"> <li>• Quantity of on-site generation [kWh]</li> <li>• Emission factor for on-site generation (as applicable) [kgCO<sub>2</sub>e/kWh]</li> </ul>
Hydrogen	<ul style="list-style-type: none"> <li>• Emissions intensity of hydrogen being utilized (calculated via IPHE H2PA guidance) (kgCO<sub>2</sub>e/kgH<sub>2</sub>)</li> </ul>
Waste and other Co-products	<ul style="list-style-type: none"> <li>• Quantity of steam produced [kg]</li> <li>• Quantity of steam sold [kg]</li> <li>• Emissions allocated to steam [kgCO<sub>2</sub>e]</li> <li>• Quantity of oxygen produced (kg)</li> <li>• Quantity of oxygen sold (kg)</li> <li>• Emissions allocated to oxygen[kgCO<sub>2</sub>e]</li> </ul>

## C1.6. Ammonia Cracking for Hydrogen Production

Ammonia can be decomposed or “cracked” to produce hydrogen that can then be used in its pure form. Cracking facilities are not widely utilized today but are expected to incorporate catalyst beds and high-temperature heat for decomposition. The temperature of heat required will vary widely depending on the catalyst used; values reported in the literature range from 300°C to over 1,000°C. The requisite heat can be generated via combustion of ammonia itself or combustion of part of recovered hydrogen or other fuels. An example configuration of an ammonia cracking facility is depicted in **Figure C1. 6**. Key emission sources within this pathway are described in **Table C1. 10**, and potential co-products in **Table C1. 11**.

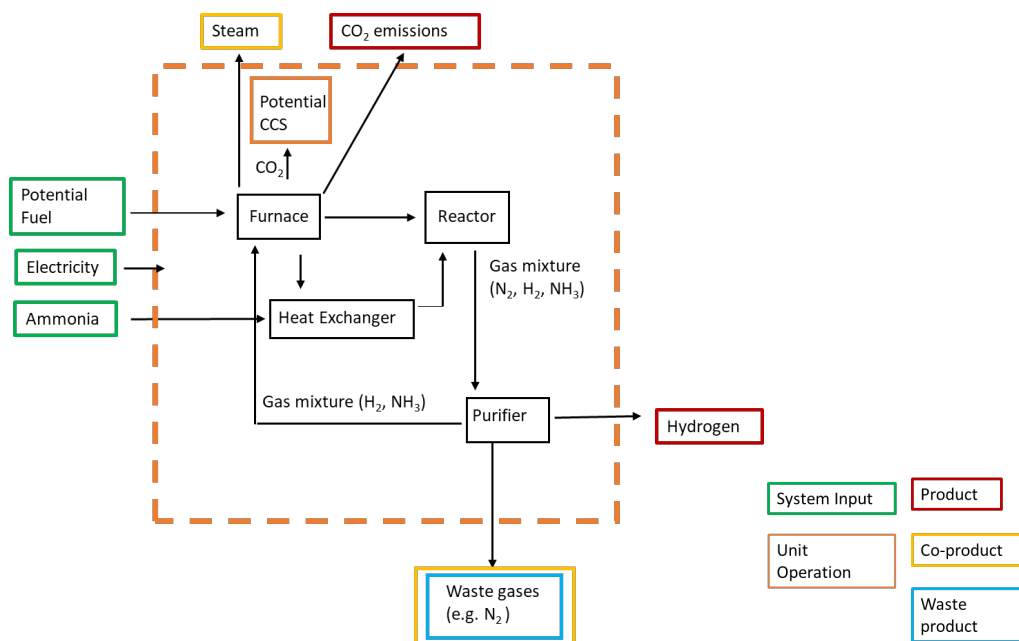

**Figure C1. 6: Example Pathway for Ammonia Cracking to Produce Low-Carbon Hydrogen, adapted from numerous sources.** <sup>65,66,67</sup>

Parameters that may vary in real-world facilities include the fuel source (e.g., in many facilities, ammonia may be combusted for heat generation or electric furnaces may be used rather than combustion of separate heating fuel), and the degree of waste gas formation, which will be influenced by the catalyst used and operating temperature

**Table C1. 10: Key Emission Sources Associated with Ammonia Cracking**

Process unit/stage	Key emissions sources	Secondary emissions sources
Furnace	<ul style="list-style-type: none"> <li>• Electricity consumption</li> <li>• Excavation of heating fuel (e.g., natural gas)</li> <li>• Delivery of heating fuel to cracking facility, including fugitive emissions and electricity or fuel consumed in transport (e.g., via pipelines or trucks) <sup>68</sup></li> <li>• Fugitive GHG emissions of heating fuel at cracking facility</li> <li>• CO<sub>2</sub> released by the furnace</li> </ul>	
CO <sub>2</sub> capture (if used)	<ul style="list-style-type: none"> <li>• Electricity and/or heat used in CO<sub>2</sub> capture units</li> </ul>	

<sup>65</sup> [https://www.energy.gov/sites/prod/files/2015/01/f19/fcto\\_nh3\\_h2\\_storage\\_white\\_paper\\_2006.pdf](https://www.energy.gov/sites/prod/files/2015/01/f19/fcto_nh3_h2_storage_white_paper_2006.pdf)

<sup>66</sup> [https://assets.publishing.service.gov.uk/government/uploads/system/uploads/attachment\\_data/file/880826/HS420 - Ecuity - Ammonia to Green Hydrogen.pdf](https://assets.publishing.service.gov.uk/government/uploads/system/uploads/attachment_data/file/880826/HS420_-_Ecuity_-_Ammonia_to_Green_Hydrogen.pdf)

<sup>67</sup> [https://escholarship.org/content/qt7z69v4wp/qt7z69v4wp\\_noSplash\\_db283f1adaa653e9f3ffd0095a664b3f.pdf](https://escholarship.org/content/qt7z69v4wp/qt7z69v4wp_noSplash_db283f1adaa653e9f3ffd0095a664b3f.pdf)

<sup>68</sup> In some cases, the heating fuel used may not be a fossil fuel. For instance, waste heat from nearby industrial processes may be used, or some of the hydrogen produced via cracking may be used. If waste heat (that would otherwise be rejected to the atmosphere) is utilized, its emissions intensity may be treated as 0. If hydrogen is utilized, its emissions should be represented using the current IPHE guidance.

	<ul style="list-style-type: none"> <li>Residual CO<sub>2</sub> which is not captured for permanent storage</li> </ul>	
Compression for transportation of CO <sub>2</sub> (if used)	<ul style="list-style-type: none"> <li>Electricity for compression of CO<sub>2</sub></li> <li>Electricity and/or gaseous fuel combustion for pipeline transport</li> <li>Fuel combustion for motive transport</li> <li>Fugitive CO<sub>2</sub> emissions</li> </ul>	
Storage of CO <sub>2</sub> (if included)	<ul style="list-style-type: none"> <li>Electricity/fuel use for storage compression and injection or transformation</li> </ul>	Fugitive CO <sub>2</sub> emissions from a permanent storage location
Compression of ammonia, nitrogen, hydrogen, or gas mixtures	<ul style="list-style-type: none"> <li>Electricity consumption</li> <li>Fugitive emissions</li> </ul>	
Heat exchanger	<ul style="list-style-type: none"> <li>Electricity consumption</li> </ul>	
Purifier	<ul style="list-style-type: none"> <li>Electricity consumption</li> </ul>	

**Table C1. 11: Potential Co-Products Associated with Ammonia Cracking**

Process unit/stage	Potential Co-Product	Recommended Emissions Accounting Method
Furnace	Steam	Subdivision by systems when feasible
Purifier	Nitrogen	System Expansion

**Table C1. 12** Describes reporting requirements for ammonia cracking facilities to demonstrate alignment with the current IPHE guidance.

**Table C1. 12: Information to be reported for Ammonia Cracking**

Category	Parameters to Report
Facility details	<ul style="list-style-type: none"> <li>Facility identity</li> <li>Facility location</li> <li>Facility capacity [t/year]</li> <li>Commencement of facility operation</li> </ul>
Product specification	<ul style="list-style-type: none"> <li>Hydrogen produced [kg]</li> <li>Hydrogen pressure level at the gate</li> <li>Hydrogen purity level at the gate [%]</li> <li>Specification of contaminants</li> </ul>
GHG emissions overview	<ul style="list-style-type: none"> <li>Emissions intensity of cracking process per kilogram of hydrogen produced [kgCO<sub>2</sub>e/kgH<sub>2</sub> produced]</li> </ul>
Batch details	<ul style="list-style-type: none"> <li>Beginning and end of batch dates</li> <li>Batch quantity</li> </ul>
Electricity	<p>Location-based emissions accounting:</p> <ul style="list-style-type: none"> <li>Quantity of purchased grid electricity [kWh]</li> <li>Location based emission factor used [kgCO<sub>2</sub>e/kWh]</li> </ul> <p>Market-based emissions accounting</p> <ul style="list-style-type: none"> <li>Quantity of purchased grid electricity [kWh]</li> <li>Quantity of contracted renewable electricity [kWh] and/or quantity of associated GOs or RECs</li> <li>Type of GOs or RECs</li> <li>Residual electricity</li> </ul>

	<ul style="list-style-type: none"> <li>Residual mix emission factor [kgCO<sub>2</sub>e/kWh]</li> </ul> On-site electricity generation <ul style="list-style-type: none"> <li>Quantity of on-site generation [kWh]</li> <li>Emission factor for on-site generation (as applicable) [kgCO<sub>2</sub>e/kWh]</li> </ul>
Other utilities	<ul style="list-style-type: none"> <li>Source/s of steam</li> <li>Quantity of purchased steam [kg]</li> <li>Quantity of steam exported [kg]</li> </ul>
Fuel feedstock	<ul style="list-style-type: none"> <li>Types of fuels combusted</li> <li>Quantities of fuel combusted [L, kg]</li> <li>Relevant emissions calculations and factors used</li> </ul>
Waste and/or co-products	<ul style="list-style-type: none"> <li>Quantity of steam produced [kg]</li> <li>Quantity of steam sold [kg]</li> <li>Emissions allocated to steam [kgCO<sub>2</sub>e]</li> <li>Quantity of nitrogen produced (kg)</li> <li>Quantity of nitrogen sold (kg)</li> <li>Emissions allocated to nitrogen [kgCO<sub>2</sub>e]</li> </ul>
Carbon dioxide treatment	<ul style="list-style-type: none"> <li>Type of CO<sub>2</sub> storage</li> <li>Location of CO<sub>2</sub> storage</li> <li>Transport type of CO<sub>2</sub> to a storage location (if applicable)</li> <li>Quantity of CO<sub>2</sub> captured [kg]</li> <li>Quantity of CO<sub>2</sub> stored [kg]</li> <li>Quantity of CO<sub>2</sub> sold [kg]</li> <li>Quantity of fugitive emissions created during injection of CO<sub>2</sub> into the storage location [kg]</li> <li>Quantity of fugitive CO<sub>2</sub> emissions from storage [kg] (in line with the period covered by the reporting)</li> </ul>



## Appendix C2: Liquid Hydrogen as carrier

### C2.1. Liquefaction

Hydrogen is liquefied to enable its delivery and/or storage at a higher density than feasible in gaseous form. Large-scale hydrogen liquefaction plants are typically co-located with gaseous hydrogen production facilities, and liquid hydrogen is delivered to end uses in cryogenic liquid tanker trucks. The emissions associated with hydrogen liquefaction are due primarily to onsite electricity generation. Each kilogram of hydrogen typically requires about 10-15 kWh of electricity to liquefy, consumed mainly by compressors.<sup>69,70</sup> Many different pathways to improve the efficiency of conventional liquefaction have been proposed or explored in R&D projects to date, including the use of mixed refrigerants instead of liquid nitrogen for precooling, utilization of liquefied natural gas at regasification terminals, or helium or neon for liquefaction; closer integration of nitrogen liquefaction and hydrogen liquefaction plants; the use of higher efficiency compressors; power generation during hydrogen expansion (e.g., through use of turboexpanders); and novel alternatives to mechanical cycles, such as the use of magnetocaloric materials.<sup>69,70,71,72,73</sup> section C2.3 describes the steps in conventional hydrogen liquefaction and a corresponding recommended approach to emissions analysis. The approach described also applies to any method of hydrogen liquefaction that accepts pure hydrogen gas (99%) as a feedstock, utilizes pre-cooling gases, and uses only electricity as the external energy source.

### C2.2. System boundary

Key steps within the hydrogen liquefaction and delivery supply chain are described in **Figure C2. 1** below. The guidance in Section C2.3 describes the mechanism to characterize the combined emissions of Modules 2 and 3. The emissions associated with Module 1 should be calculated per the IPHE's "Methodology for determining the greenhouse gas emissions associated with the production of hydrogen." Future IPHE guidance will describe emissions associated with Module 4.

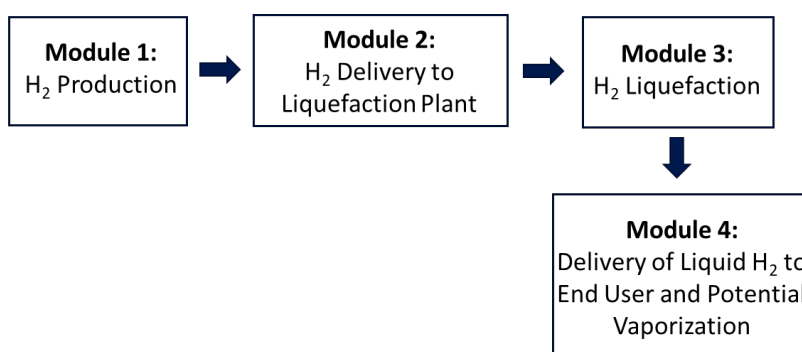

**Figure C2. 1: Modules for Life Cycle Analysis of Hydrogen Liquefaction**

<sup>69</sup> <https://doi.org/10.1016/j.ijhydene.2010.02.109>

<sup>70</sup> <https://doi.org/10.1016/j.ijhydene.2020.09.188>

<sup>71</sup> <https://www.mdpi.com/1996-1073/14/18/5917>

<sup>72</sup> <https://doi.org/10.1016/j.ijhydene.2017.03.167>

<sup>73</sup> <https://link.springer.com/article/10.1007/s11708-019-0657-4>

The reporting metric for life cycle analysis of Modules 1-4 is kgCO<sub>2e</sub>/kgH<sub>2</sub>. The current guidance recommends that the functional unit (kg H<sub>2</sub>) reflect the mass of liquid hydrogen delivered to the end user at the end of Module 4. This unit implicitly accounts for hydrogen boil-off during the liquefaction process, bulk storage, and hydrogen delivery. Consequently, within the reporting metric, emissions will only be leveled only over the hydrogen the end user ultimately receives.

### C2.3. Hydrogen Liquefaction Pathway

Hydrogen liquefaction plants are typically co-located with hydrogen production facilities, so delivery of the hydrogen from a production facility to the liquefaction plant (Module 2 of **Figure C2. 1**) is not required. If gaseous hydrogen is delivered between a production plant and a liquefaction plant that are not co-located, pipelines are the delivery mode most likely to be utilized. If pipeline delivery is used, emissions associated with compressors within the pipeline infrastructure must be accounted for.

Hydrogen liquefaction typically relies on the Claude cycle or similar mechanical pathways. While configurations of individual plants can vary, large-scale liquefaction generally entails pre-cooling of the hydrogen gas below its inversion temperature<sup>74</sup> with liquid nitrogen that is typically produced onsite, use of turbines and expanders to reduce pressure and temperature, and use of a Joule-Thomson throttling valve to further reduce temperature to 20 K to condense/liquefy hydrogen. Cold hydrogen flash gas is commonly recycled to precool inlet hydrogen streams throughout the process. Compressors pressurize the hydrogen before expansion, followed by heat rejection to facilitate a larger pressure and temperature drop. Additionally, catalytic converters are integrated throughout the liquefaction process to convert ortho isomers of hydrogen to para isomers, such that the liquid hydrogen supplied to a consumer is ultimately >95% para. The para isomer of hydrogen has a lower energy state than ortho at 20 K. As such, without catalytic conversion, ortho hydrogen will spontaneously convert to para over the course of days to weeks. The ortho-para conversion is exothermic and would result in boil-off losses of stored hydrogen if allowed to occur spontaneously in the absence of conversion. Catalysis of this conversion is incorporated into hydrogen liquefaction plants to mitigate subsequent boil-off losses once the hydrogen is liquefied and placed in storage or loaded for shipping.<sup>75,76</sup>

Refrigerants used for pre-cooling in hydrogen liquefaction, such as liquid nitrogen, need to be either continuously re-cooled or liquefied or be continuously replaced with new batches of cold refrigerant. Both cases must account for the energy consumption and co-products associated with cooling the refrigerant. Co-products are more likely to be generated in open cycles, wherein the refrigerant is replaced rather than recycled throughout the process.

---

<sup>74</sup> The inversion temperature of a gas at any pressure is the critical temperature above which the Joule-Thomson (J-T) coefficient is negative; i.e., the gas temperature increases as its pressure is decreased with iso-enthalpic expansion. Gases at temperature below their inversion point have positive J-T coefficient, i.e., the gas temperature decreases as its pressure is decreased with iso-enthalpic expansion.

<sup>75</sup> Baker, C. R. (1975). Efficiency and Economics of Large Scale Hydrogen Liquefaction. SAE Transactions, 84, 3104–3113. <http://www.jstor.org/stable/44633641>

<sup>76</sup> [https://www.idealhy.eu/uploads/documents/IDEALHY\\_D1-1\\_Report\\_Tech\\_Overview\\_and\\_Barriers\\_web2.pdf](https://www.idealhy.eu/uploads/documents/IDEALHY_D1-1_Report_Tech_Overview_and_Barriers_web2.pdf)

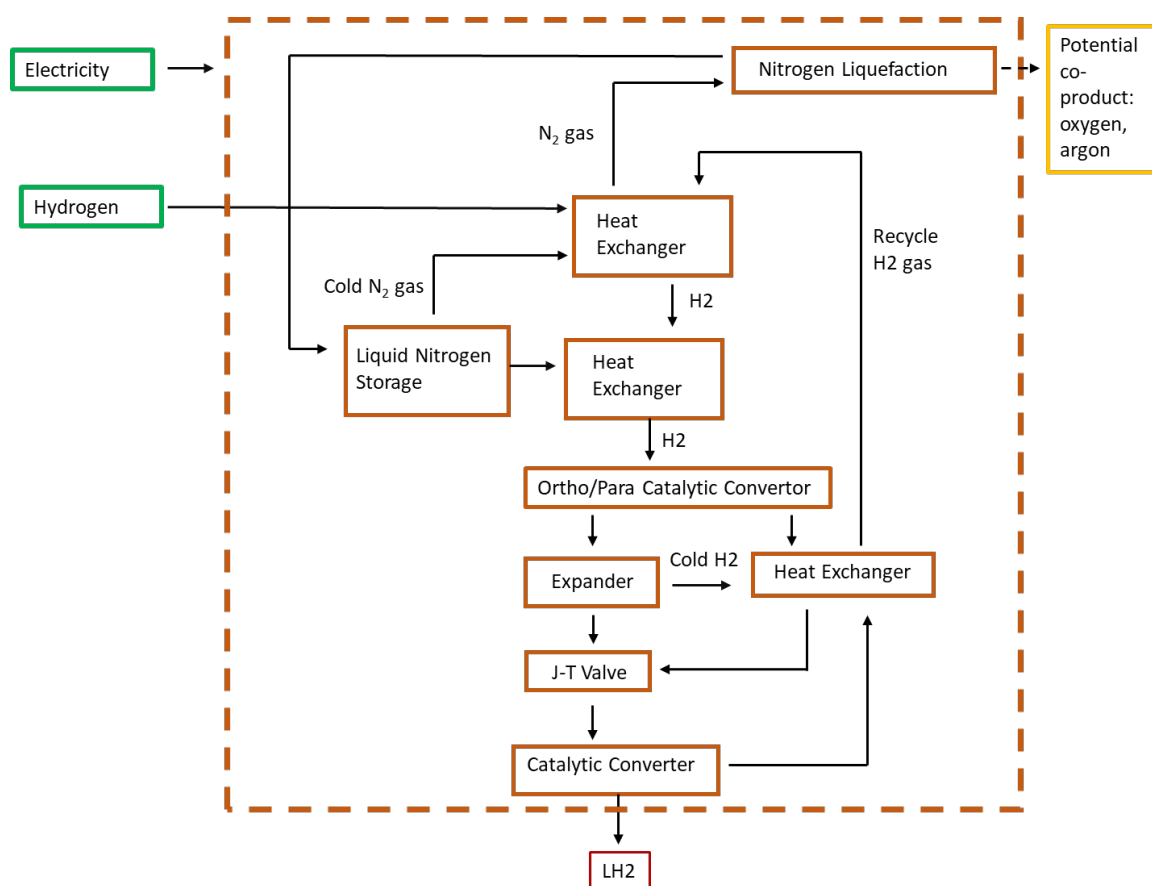

### Legend

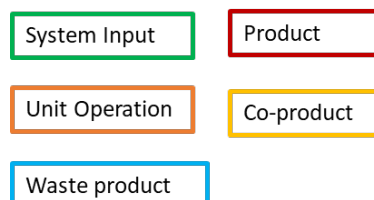

**Figure C2. 2: Configuration of conventional hydrogen liquefaction plants based on the Claude cycle**

*Compressors are not depicted in this figure but are incorporated throughout the plant to pressurize hydrogen before expansion and transfer hydrogen between components. Figure adapted from [75]*

Emissions that should be accounted for in the life cycle analysis of hydrogen liquefaction are described in **Table C2. 1**.

Potential co-products associated with liquid nitrogen generation, in scenarios where the nitrogen supply is being replenished throughout the process rather than recycled, are described in **Table C2. 2**.

**Table C2. 1: Key Emission Sources in Hydrogen Liquefaction**

Process unit/stage	Key emissions sources	Secondary emissions sources
Hydrogen delivery to a liquefaction plant	<ul style="list-style-type: none"><li>• Electricity consumed or fuel burned in pipeline compressors</li></ul>	
Hydrogen liquefaction	<ul style="list-style-type: none"><li>• Electricity consumed onsite to power cooling or liquefaction of refrigerant (e.g., nitrogen, mixed refrigerant, helium) and hydrogen liquefaction facility (e.g., for compression).</li></ul>	

**Table C2. 2: Potential Co-Products and Emissions Accounting Framework for Hydrogen Liquefaction**

Step	Potential Co-Products	Recommended Approach to Emissions Accounting
Air separation unit for nitrogen supply	Oxygen, Argon	Use of allocation factors specified in the Ecoinvent database, as further described in the IPHE “Methodology for determining the greenhouse gas emissions associated with the production of hydrogen” <sup>77</sup>

<sup>77</sup> [https://db.ecoinvent.org/reports/08\\_Chemicals.pdf](https://db.ecoinvent.org/reports/08_Chemicals.pdf)

## Appendix C3: LOHCs as Hydrogen Carriers

### C3.1. LOHC Process Description

Liquid organic hydrogen carriers (LOHC) are easily transportable materials that can undergo relatively facile hydrogenation and subsequent dehydrogenation to utilize as an alternative to high pressure or cryogenic hydrogen delivery. While LOHCs are still in the early stages of commercialization, their potential advantages include their compatibility with existing gasoline infrastructure (e.g., existing pipelines), high density of hydrogen compared to gaseous storage vessels, high boiling point relative to liquid hydrogen, and, depending on the compound, low toxicity.<sup>78</sup>

LOHC production involves hydrogenating a chemical feedstock, such as toluene or dibenzyltoluene (DBT), over catalyst beds. In the current guidance, the term “LOHC” refers to the hydrogenated compound, such as methylcyclohexane or perhydro-DBT, and “feedstock” refers to the toluene or DBT that was hydrogenated. LOHCs are intended to be transported long distances and then dehydrogenated (i.e., “cracked”) near the point of use to release hydrogen.

Many different feedstocks have been explored for use in LOHCs in RD&D efforts worldwide, including toluene, dibenzyltoluene (DBT), benzene, and N-ethylcarbazole. The current guidance focuses specifically on systems using toluene or DBT feedstock to produce methylcyclohexane (MCH) or perhydro-DBT (PDBT), respectively. Future IPHE guidance may address other LOHC systems.

### C3.2. Output Metrics and System boundary

Key sources of emissions in the LOHC pathway can be categorized into modules, described in **Figure C3. 1** below. While the design and configurations of hydrogenation/dehydrogenation (i.e., “cracking”) facilities can vary widely, they generally entail exothermic hydrogenation, endothermic dehydrogenation, recycling of the feedstock chemical (e.g., toluene or DBT) between the point of dehydrogenation and hydrogenation, and use of “makeup” feedstock in the hydrogenation step to account for losses during the hydrogenation/dehydrogenation cycles. As shown in **Figure C3. 3**, a LOHC can also be directly produced, bypassing hydrogen production and delivery in a process called Direct MCH production (DMCH).

The guidance below in Section C3.3 describes the mechanisms to characterize emissions of Modules 3, 4, and 6. The emissions associated with Module 1 should be calculated per the IPHE’s “Methodology for determining the greenhouse gas emissions associated with the production of hydrogen,”<sup>79</sup> with one exception regarding the reporting unit.

Future IPHE guidance will describe the methodology for calculating the emissions associated with modules 2, 5, and 7.

---

<sup>78</sup> <https://pubs-acscs-proxy.scejournals.org/doi/pdf/10.1021/acs.energyfuels.9b00296>

<sup>79</sup> [https://www.iphe.net/files/ugd/45185a\\_ef588ba32fc54e0eb57b0b7444cfa5f9.pdf](https://www.iphe.net/files/ugd/45185a_ef588ba32fc54e0eb57b0b7444cfa5f9.pdf)

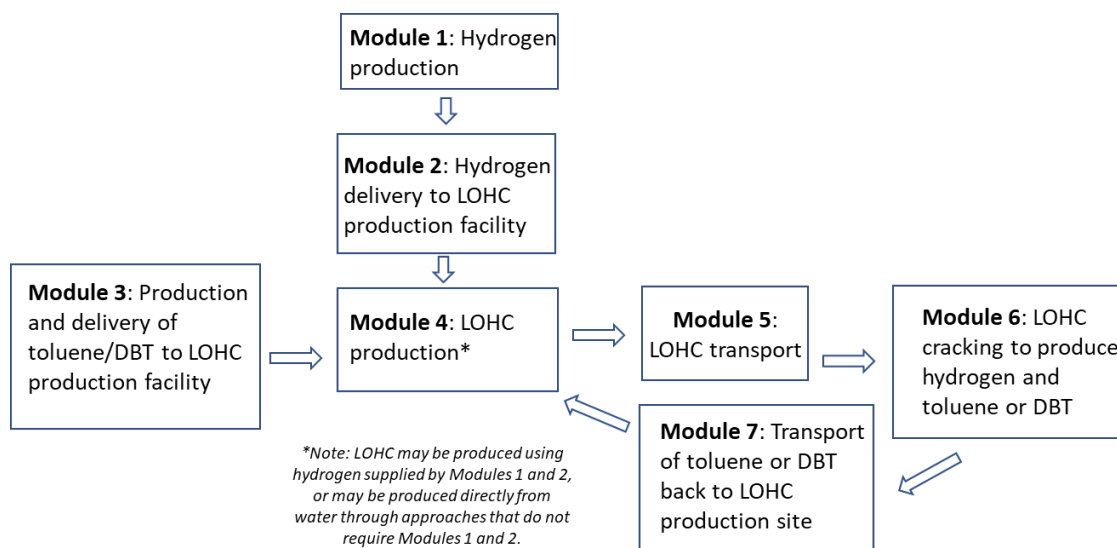

**Figure C3. 1: Modules for Life Cycle Analysis of LOHCs**

The current guidance recommends the use of the following reporting metric for life cycle analysis:

- Kilograms of carbon dioxide equivalent per kilogram of hydrogen (i.e. kgCO<sub>2</sub>e/kgH<sub>2</sub>). The numerator corresponds to the sum of emissions associated with Modules 1-7. In a given deployment, if a Module does not occur (e.g., if hydrogen is not separately produced in delivered, in the case of direct LOHC production), then its emissions associated with that module can be treated as zero.

The current guidance recommends that the functional unit (kgH<sub>2</sub>) reflect the mass of hydrogen produced by the cracking facility at the end of Module 6.

### C3.3. LOHC Production

As shown in **Figure C3. 2**, the production of MCH or PDBT commonly entails passing the feedstock (toluene or DBT) through a heat exchange, mixing the feedstock with hydrogen, and then passing the mixture through a reactor with catalyst beds. Real-world facilities can vary concerning heat integration, and the temperature and pressure of the feedstock mixed with hydrogen will determine the amount of LOHC produced.<sup>80,81</sup> An emerging alternative is the direct use of water and electricity without a separate hydrogen supply. This pathway, depicted in **Figure C3. 3**, is currently in the early stages of commercialization.

The toluene feedstock used in MCH production is typically produced during the petroleum refining process.<sup>82</sup> DBT is made from toluene and benzyl chloride. Once the toluene or DBT is produced, it would be delivered to a LOHC production facility (unless the LOHC system was onsite) for hydrogenation.<sup>83</sup>

<sup>80</sup> <https://www.mdpi.com/1996-1944/13/2/277>

<sup>81</sup> <https://www.sciencedirect.com/science/article/abs/pii/S0360319921016815>

<sup>82</sup> [https://www.euro.who.int/\\_data/assets/pdf\\_file/0020/123068/AQG2ndEd\\_5\\_14Toluene.PDF](https://www.euro.who.int/_data/assets/pdf_file/0020/123068/AQG2ndEd_5_14Toluene.PDF)

<sup>83</sup> <https://ec.europa.eu/research/participants/documents/downloadPublic?documentIds=080166e5c551f4c2&appld=PPGMS>

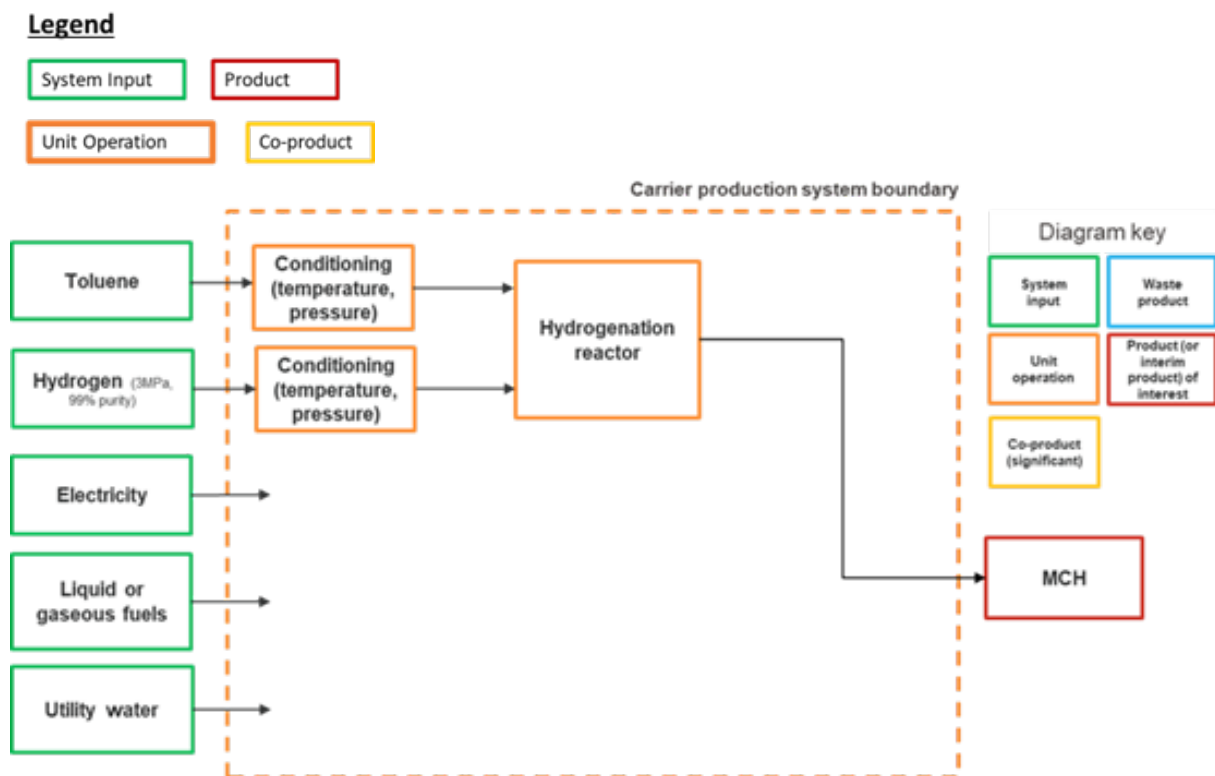

**Figure C3. 2: Example configuration of common LOHC production pathways.**

Key attributes of real-world facilities that will commonly vary include the degree of condensation, the manner of heat integration, and whether purge gases are disposed of as waste products (e.g., vented) or burned for heat generation. Figure adapted from [81].

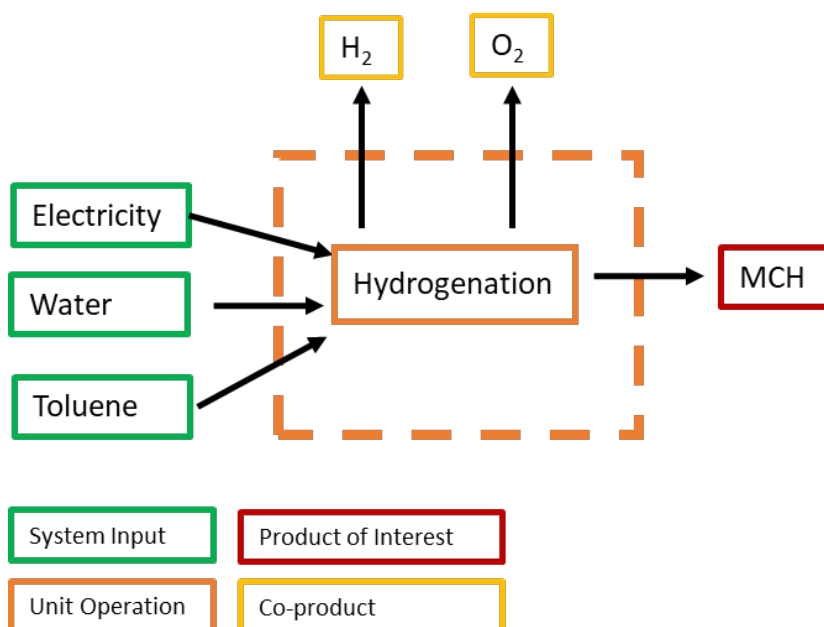

**Figure C3. 3: Example configuration of Direct MCH Pathway.**

The pathway is currently in the early stages of commercialization.

Once a LOHC is delivered to a cracking facility, the cracking process releases the original feedstock (toluene or DBT) and hydrogen. If carriers are used for large-scale commercial transport, it is expected that, in most cases, most toluene or DBT feedstock will be sent back to the original hydrogenation facility for reuse or valorized regionally for other purposes (e.g., chemicals production) and that the remainder will be lost to the atmosphere. To produce a new batch of LOHC, the original hydrogenation facility will typically utilize any toluene or DBT feedstock returned to the facility and supplement this feedstock with “makeup” feedstock. This “makeup” refers to new feedstock produced to compensate for feedstock that was not returned (e.g., due to losses at the cracking facility). In scenarios where cracking losses are low, and most toluene or DBT produced at the cracking facility is returned to the site of hydrogenation, the contribution of the emissions associated with the makeup feedstock manufacturing to the carbon intensity of hydrogen is expected to be low. However, in scenarios where losses during cracking or transport are high, the emissions associated with manufacturing makeup feedstock may become substantial.

To account for this variability, the IPHE guidance recommends that emissions associated with the production of makeup toluene or DBT be accounted for in evaluating the emissions of LOHC. The emissions associated with manufacturing the original batch of feedstock for a facility of a given capacity may be excluded from the system boundary, as this feedstock is expected to be leveled throughout hydrogen production over many years and ultimately represent a small share of life cycle emissions for hydrogen delivery from LOHCs considered in the current document (MCH and PDBT).<sup>84</sup> Across IPHE guidance documents, emissions associated with manufacturing the equipment used in hydrogen production (e.g., renewable or fossil generators, electrolyzers) are currently similarly excluded from the scope of analysis. To distinguish the emissions associated with manufacturing makeup toluene/DBT from those associated with manufacturing an original batch, this IPHE guidance proposes two approaches to quantifying the amount of makeup toluene:

1. Stakeholders engaged in manufacturing LOHCs may report the total amount of toluene or DBT used for the production of LOHCs within a specified analysis period (e.g., one year), as well as the amount returned by LOHC cracking facilities to the LOHC production facility. The balance of feedstock represents the makeup, and emissions associated with this makeup must be reported.

$$\begin{aligned}
 &\textit{Makeup Feedstock (million metric tonnes [MMT])} \\
 &= \textit{Feedstock used to produce LOHC (MMT)} \\
 &- \textit{Feedstock recieved from LOHC cracking facilities (MMT)}
 \end{aligned}$$

Equation 1: Quantity of Makeup Feedstock Manufactured for LOHC Production over Analysis Period.

<sup>84</sup> The life cycle emissions of toluene production are estimated at ~1.22 kgCO<sub>2</sub>e/kg-toluene. (Source: PlasticsEurope. “Benzene, Toluene, and Xylenes (Aromatics, BTX)”. February 2013. [http://gabi-documentation-2014.gabi-software.com/xml-data/external\\_docs/PlasticsEurope%20Eco-profile%20BTX%202013-02.pdf](http://gabi-documentation-2014.gabi-software.com/xml-data/external_docs/PlasticsEurope%20Eco-profile%20BTX%202013-02.pdf)). About 20 kg toluene are expected to be needed for each kg of H<sub>2</sub> in the production of MCH. (Source: Argonne National Laboratory. “Toluene-Methylcyclohexane as Two-Way Carrier for Hydrogen Transmission and Storage”. <https://publications.anl.gov/anlpubs/2021/11/171777.pdf> )



2. Stakeholders may meter the amount of makeup toluene produced and use the measured value instead of the estimate above.

As noted above, toluene is commonly manufactured at petroleum refineries along with other petroleum products, and DBT is manufactured from toluene and benzyl chloride.<sup>85, 86</sup> Estimates of the emissions intensity of each feedstock should account for Scope 1, 2, and partial Scope 3 emissions (excluding emissions associated with construction, manufacturing, and decommissioning of capital goods, business travel, employee commuting, and upstream leased assets). Since manufacturing processes for each feedstock are not expected to vary widely within each region, stakeholders may use region-specific emissions factors in the life cycle analysis of LOHCs. As the market for LOHCs develops, it is expected that such region-specific analysis will be documented, and standardized databases and guidance documents will be developed to inform LCA.

**Table C3. 1** summarizes key sources of greenhouse gas emissions from MCH or PDBT production, and **Table C3. 3** summarizes key sources of emissions during the cracking of the carriers. **Table C3. 2** and **Table C3. 4** summarize potential co-products that could be allocated emissions in LOHC production and cacking processes.

**Table C3. 1: Key Life Cycle GHG Emission Sources in LOHC Manufacturing**

Process unit/stage	Key emissions sources	Secondary emissions sources
Toluene production	<ul style="list-style-type: none"> <li>• Extraction of petroleum feedstock</li> <li>• Delivery of petroleum to the refinery</li> <li>• Emissions allocated to toluene at the petroleum refinery, e.g., due to fuel combustion or electricity consumption</li> </ul>	Toluene losses onsite
Dibenzyltoluene production	<ul style="list-style-type: none"> <li>• Emissions intensity of toluene manufacturing</li> <li>• Emissions intensity of chlorine production and subsequent benzyl chloride manufacturing</li> <li>• Electricity consumption at the DBT manufacturing facility</li> <li>• Emissions at point of DBT manufacture due to fuel combustion</li> </ul>	DBT losses onsite
Hydrogenation facility	<ul style="list-style-type: none"> <li>• Emissions of electricity consumption, calculated in a manner consistent with previous IPHE guidance<sup>79</sup></li> <li>• Potential fuel combustion.<sup>87</sup> Emissions should reflect CO<sub>2</sub> emissions onsite as well as emissions intensity of upstream fuel extraction, processing, and delivery. Emissions intensity of fuel extraction, processing, and delivery should include emissions of all associated electricity consumption, fuel combustion, and fugitive releases.</li> </ul>	

<sup>85</sup> [PlasticsEurope Eco-profile BTX Final 2013-03-05.doc \(gabi-software.com\)](https://ec.europa.eu/research/participants/documents/downloadPublic?documentId=080166e5c551f4c2&appid=PPGMS)

<sup>86</sup> <https://ec.europa.eu/research/participants/documents/downloadPublic?documentId=080166e5c551f4c2&appid=PPGMS>

<sup>87</sup> Fuel combustion is not expected at all facilities, and will be negligible in many cases.





**Table C3. 3: Key Life Cycle GHG Emission Sources in LOHC Dehydrogenation/Cracking**

Process unit/stage	Key emissions sources	Secondary emissions sources
Furnace	<ul style="list-style-type: none"> <li>Excavation of heating fuel (e.g., natural gas)<sup>88</sup></li> <li>Delivery of heating fuel to cracking facility, including fugitive emissions and electricity or fuel consumed in transport (e.g., via pipelines or trucks)<sup>88</sup></li> <li>Fugitive GHG emissions of heating fuel at cracking facility</li> <li>CO<sub>2</sub> released by the furnace</li> </ul>	
Dehydrogenation reactor	<ul style="list-style-type: none"> <li>Electricity consumption. Emissions of electricity consumption should be calculated in a manner consistent with previous IPHE guidance<sup>79</sup></li> </ul>	

**Table C3. 4: Potential Co-Products and Emissions Accounting Framework for Dehydrogenation**

Step	Potential Co-Products	Recommended Approach to Emissions Accounting
Furnace/dehydrogenation reactor	Waste heat	Energy
Dehydrogenation Reactor	Toluene or DBT that is not returned to the hydrogenation facility but valorized in other markets	System expansion, using a region-specific emissions factor developed to include parameters described in Table C3. 1: Key Life Cycle GHG Emission Sources in LOHC Manufacturing

**Table C3. 6** describes reporting requirements for LOHC producers to demonstrate their alignment with the current IPHE guidance.

**Table C3. 5: Information to be Reported for MCH or PDBT Production Facilities**

Category	Parameters to Report
Facility details	<ul style="list-style-type: none"> <li>Facility identity</li> <li>Facility location</li> <li>Facility capacity [t/year]</li> <li>Commencement of facility operation</li> </ul>
Product specification	<ul style="list-style-type: none"> <li>Quantity of LOHC produced [tons]</li> </ul>
Batch details	<ul style="list-style-type: none"> <li>Beginning and end of batch dates</li> <li>Batch quantity [tons]</li> </ul>
Electricity	Location-based emissions accounting: <ul style="list-style-type: none"> <li>Quantity of purchased grid electricity [kWh]</li> <li>Location based emission factor used [kgCO<sub>2</sub>e/kWh]</li> </ul> Market-based emissions accounting <ul style="list-style-type: none"> <li>Quantity of purchased grid electricity [kWh]</li> <li>Quantity of contracted renewable electricity [kWh] and/or quantity of associated GOs or RECs</li> </ul>

<sup>88</sup> In some cases, the heating fuel used may not be a fossil fuel. For instance, waste heat from nearby industrial processes may be used, or some of the hydrogen produced via cracking may be used. If waste heat (that would otherwise be rejected to the atmosphere) is utilized, its emissions intensity may be treated as 0. If hydrogen is utilized, its emissions should be represented using the current IPHE guidance.

	<ul style="list-style-type: none"> <li>Type of GOs or RECs</li> <li>Residual electricity</li> <li>Residual mix emission factor [kgCO<sub>2</sub>e/kWh]</li> </ul> On-site electricity generation <ul style="list-style-type: none"> <li>Quantity of on-site generation [kWh]</li> <li>Emission factor for on-site generation (as applicable) [kgCO<sub>2</sub>e/kWh]</li> </ul>
Feedstock	<ul style="list-style-type: none"> <li>Total amount of toluene and/or DBT consumed to produce LOHCs within the analysis period, including makeup toluene/DBT and recycled toluene/DBT (tons)</li> <li>Total amount of toluene and/or DBT received from LOHC cracking facilities [tons]</li> <li>Total amount of “makeup” toluene and/or DBT consumed (calculated based on Equation 1 or directly measured as indicated in the description) [tons]</li> <li>Emissions factor used to determine emissions intensity of toluene and/or DBT [kgCO<sub>2</sub>e/kg-toluene or kgCO<sub>2</sub>e/kg-DBT]</li> <li>Total amount of water consumed for the Direct MCH pathway [L]</li> </ul>
Waste and other co-products	<ul style="list-style-type: none"> <li>Quantity of steam produced [kg]</li> <li>Quantity of steam sold [kg]</li> <li>Emissions allocated to steam [kgCO<sub>2</sub>e]</li> <li>Quantity of H<sub>2</sub> produced and sold in case of Direct MCH pathway [tons]</li> <li>Quantity of O<sub>2</sub> produced and sold in Direct MCH pathway [tons]</li> </ul>

**Table C3. 6: Information to be reported for MCH or PDBT Dehydrogenation Facilities**

Category	Parameters to Report
Facility details	<ul style="list-style-type: none"> <li>Facility identity</li> <li>Facility location</li> <li>Facility capacity [tons/year]</li> <li>Commencement of facility operation</li> </ul>
Product specification	<ul style="list-style-type: none"> <li>Quantity of hydrogen produced [tons]</li> <li>Quantity of toluene or DBT produced [tons]</li> <li>Purity (%) and pressure (MPa) of hydrogen produced</li> </ul>
Batch details	<ul style="list-style-type: none"> <li>Beginning and end of batch dates</li> </ul>
Electricity	Location-based emissions accounting: <ul style="list-style-type: none"> <li>Quantity of purchased grid electricity [kWh]</li> <li>Location based emission factor used [kgCO<sub>2</sub>e/kWh]</li> </ul> Market-based emissions accounting <ul style="list-style-type: none"> <li>Quantity of purchased grid electricity [kWh]</li> <li>Quantity of contracted renewable electricity [kWh] and/or quantity of associated GOs or RECs</li> <li>Type of GOs or RECs</li> <li>Residual electricity</li> <li>Residual mix emission factor [kgCO<sub>2</sub>e/kWh]</li> </ul> On-site electricity generation <ul style="list-style-type: none"> <li>Quantity of on-site generation [kWh]</li> <li>Emission factor for on-site generation (as applicable) [kgCO<sub>2</sub>e/kWh]</li> </ul>

Fuel used in furnace	<ul style="list-style-type: none"> <li>• Type of fuel used (e.g., natural gas)</li> <li>• Quantity of fuel used to produce heat [e.g. mmBTU]</li> <li>• Emissions intensity of fuel used, including all emissions associated with fuel extraction, transporting to a processing plant, and processing [e.g. kgCO<sub>2</sub>e/mmbtu]</li> </ul>
Furnace	<ul style="list-style-type: none"> <li>• CO<sub>2</sub> emissions from furnace [kgCO<sub>2</sub>e]</li> </ul>
Products	<ul style="list-style-type: none"> <li>• Total amount of MCH and/or PDBT produced [tonnes]</li> <li>• Total amount of MCH and/or PDBT returned to cracking facility [tonnes]</li> <li>• Total amount of MCH and/or PDBT valorized as a co-product in other industries [tonnes]</li> <li>• Total amount of hydrogen produced [tonnes]</li> </ul>
Waste heat	<ul style="list-style-type: none"> <li>• Quantity of steam produced [kg]</li> <li>• Quantity of steam sold [kg]</li> <li>• Emissions allocated to steam [kgCO<sub>2</sub>e]</li> </ul>
Waste products	<ul style="list-style-type: none"> <li>• Toluene or DBT losses during cracking<sup>89</sup> [kg]</li> </ul>
CO <sub>2</sub> capture	<ul style="list-style-type: none"> <li>• Amount of electricity and/or heat used in CO<sub>2</sub> capture</li> </ul>
Compression for transportation of CO <sub>2</sub>	<ul style="list-style-type: none"> <li>• Amount of electricity used and/or fuel combusted for compression and pipeline transport of CO<sub>2</sub></li> <li>• Amount of electricity used and/or fuel combusted to load CO<sub>2</sub> into trucks</li> <li>• Amount of fuel burned for truck transport of CO<sub>2</sub> [L]</li> <li>• Fugitive CO<sub>2</sub> emissions [kgCO<sub>2</sub>e]</li> </ul>

<sup>89</sup> Estimates of losses may be valuable in the context of other sustainability metrics, as toluene is a volatile organic compound.

